

# ILS = Tradition and Technology

---

ILS is based in Stützerbach, a tiny village in the beautiful forest of Thuringia, in the heart of Germany. Though small in size, Stützerbach has made its name throughout the world and can claim to a long history in glassware.



Since the first glass company was founded in 1674 Stützerbach has been a place of innovation: the German thermometer (1830), the electric bulb (1883), the vacuum flask (1895) as well as the Röntgen X-ray tube (1893) were all first developed in Stützerbach.

ILS was founded in 1992 implementing the skills and expertise of the people in



the area. More than 1,000 types and variations of microsyringes are manufactured here today. Syringes range from 0.5  $\mu$ l to 100 ml for precision sampling and dosage in chromatography, spectroscopy, preparation of standard solutions, for manual

application, and for use in autosamplers, diluters, dispensers and other liquid handling instruments. Precision diluter valves are also available as a recent addition to the production range.

ILS shrinks its own precision bore tubing from 3.3 borosilicate glass, a highly resistant borosilicate glass and all metal parts and PTFE-seals are made in-house. State of the art computer controlled equipment such as milling machines, lathes and glass shrinking equipment, together with years of glass working experience, guarantee the optimum quality of the products.

# Syringe Production

---

## Precision Glass Work

I LS employs experienced and skilled craftsmen to produce high quality glassware.



## Modern Glass Technology

Precesion machinery, mainly developed in-house, is used for the manufacturing of our syringes.

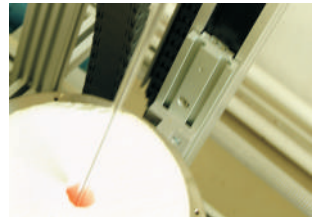

## CNC - Metal and Plastic Machining

State of the art computer controlled machines as mills, turning machines, and high precision tools guarantee the high quality of seals, plungers, fittings etc.

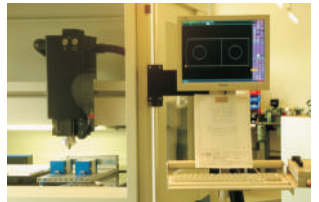

## Careful Assembly

Thoroughly trained personnel add the final touch to our products.



## Quality Control

Each product is meticulously checked



# Seals

---

## Seals with different materials for your specifically application:

PTFE-seal  
-virginal-



- high chemical resistance

PTFE-seal  
-modified-



- PTFE with lubrication for automatic liquid handling  
- longer lifetime  
- lower friction

PTFE-black-seal  
-special PTFE-



- high chemical resistance  
- less friction than virgin PTFE  
- less electrostatic charge  
- higher robustness  
- less „cold flow“  
- higher longevity

For syringes with PTFE-Black-Seal  
please add "BL" to catalog number (xxxxxx-BL).

PE-HD-seal  
-Polyethylene  
High Density-



-better durability than virginals  
PTFE when working with salty  
solutions

# Contents

---

<b>ILS = Tradition and Technology</b>	1
<b>Syringe Production</b>	2
<b>Seals</b>	3
<b>Needle Tip Styles</b>	6
<b>Syringe Needles</b>	
1. Removable Needles for ILS Syringes	7
2. NLL Needles with Metal Luer-Screw	8
3. KNLL Needles with Plastic Luer-Screw	9
<b>Dosage of Liquids: Series N</b>	
1. Fixed Needles	10
2. Fixed Needles, Customized Length, with Guide	11
3. Removable Needles	12
4. Removable Needles, Customized Length, with Guide	13
5. TLL PTFE-Luer-Lock	14
6. Super Elastic Plungers - Hi-Res	15
<b>Dosage of Liquids: Series SN</b>	
1. With Extended Handle	16
2. With Extended Handle, Customized Length & Replacement Barrels	17
<b>Dosage of Liquids: Series T</b>	
1. Zero Dead Volume Syringes	18
2. Replacement Parts	19
<b>Dosage of Gas and Liquids: Series H</b>	
1. Fixed Needles	20
2. Fixed Needles, Customized Length	21
3. Removable Needles	22
4. Removable Needles, Customized Length	23
5. LT Glass-Luer-Tip without needle	24
6. TLT PTFE-Luer-Tip without needle	25
7. TLL PTFE-Luer-Lock	28
<b>Dosage of Gas and Liquids: Series SH</b>	
1. With Extended Handle	26
2. With Extended Handle, Customized Length & Replacement Barrels	27
<b>Dosage of Gas and Liquids: Series G</b>	
With Static PTFE-Seal Topping the Glass Barrel	29
<b>Dosage of Gas and Liquids: Series P</b>	
1. With Adjustable PTFE-Seal	30
2. With Adjustable PTFE-Seal, Customized Length	31
<b>Syringes for Headspace Analysis</b>	32

# Contents

---

## Syringes for GC Autosamplers

---

1. Agilent Technologies (HP) 7670, 7671, 7672	34
2. Agilent Technologies (HP) 7673 – 7683	35
3. LEAP Technologies, CTC A200S	38
4. Shimadzu AOC	39
5. Perkin Elmer	40

## Syringes for GC Headspace Sampling

---

Thermo Quest ,Thermo Finnigan, CTC, LEAP, Dani ALS	41
--	----

## HPLC-Syringes

---

1. Most Common Valves	42
2. Waters Valves	43
3. Valco VSF-1 Valves	44

## HPLC-Syringes for Autosampler

---

1. Gynkotek Dionex Gina, Agilent (HP) 1090A, Hitachi	45
2. Waters, Spark, Kontron	46
3. LEAP Technologies, CTC HTS PAL/ LC PAL	48
4. Thermo Finnigan, Thermo Separation, Varian, Perkin Elmer, Shimadzu SIL 6	50

## Syringes for TLC

---

Camag Linomat III and IV	51
--------------------------	----

## Syringes for Automatic Liquid Handling

---

1. PTFE-Seals, Chemically Resistant Heavy Duty Syringes	
DX/ DAD/ DX/ C/ CX/ RQ	52
TLL/ TLL-X/ H-KP/ XL/ XLP/ H-Gi 402/ H-Gi 401	54
XP-PD/ H-PD/ XP-XL/ XL-XP V3/ XP	56
2. Modified PTFE-Seals for Buffers	
AD/ DAD/ DX/ C/ CX	58
TLL/ TLL-X/ RQ/ XL	60
H-PD/ XE/ XP	62
3. Special PE-Seals for Smoother Operation	
AD/ DAD/ DX/ C/ CX	64
TLL/ TLL-X/ H-KP/ RQ/ XL/ XLP	66
H-PD/ XE/ XP	68
4. ABI, Abbott, Selectra, H-I, Varian	70

## Valves

---

RQ-Zinsser/Qiagen ILS/Stratec XE-Tecan/Cavro Cybertron	72
XP-Tecan/Cavro Sampling Valve	73

## Syringes with PEEK-Tubing Connectors

---

## Accessories for Connectors

---

## Syringes with Adjustable Internal Stopper

---

## Syringes with Push Button Valve

---

## Accessories

---

# Needle Tip Styles

---



## Needle Tip "a"

This tip is designed for optimum penetration of the septa and prevents septa coring. The 17° bevel is the proven standard. In addition our electro tapered tip minimizes the necessary piercing force and diameter of the injection channel.



## Needle Tip "b"

This tip has a 90° bevel for precise pipetting. This design releases drops completely, for maximum reproducibility. It is widely used for HPLC sample injection.



## Needle Tip "c"

This tip has been specially designed for autosamplers in routine applications. The electro tapered tip and the polished 90° square end eliminate burrs. It is ideal for PTFE laminated seals and regular septas.



## Needle Tip "d"

Tip "d" is equipped with a side opening for dispensing and filling. This design avoids plugging and minimizes septum damage. It is ideal for thicker septa,

# Syringe Needles

## 1. Removable Needles (RN) for ILS Syringes

O.D. mm	Length mm	Tip		Volume Pack	Volume		25 µl - 100 µl	250 µl - 10.0 ml
		Style	Tapered		5 µl	10 µl		
0.47	42	a	yes	3	<b>2865308</b>	<b>2865408</b>	-	-
0.47	42	c	no	3	<b>2834307</b>	<b>2834407</b>	-	-
0.47	51	a	yes	3	<b>2832301</b>	<b>2832401</b>	-	-
0.47	51	b	no	3	<b>2832302</b>	<b>2832402</b>	-	-
0.47	51	c	yes	3	<b>2832303</b>	<b>2832403</b>	-	-
0.47	51	d	no	2	<b>2832304</b>	<b>2832404</b>	-	-
0.55	51	a	yes	3	-	-	<b>2831013</b>	<b>2841013</b>
0.55	51	b	no	3	-	-	<b>2831014</b>	<b>2841014</b>
0.55	51	d	no	2	-	-	<b>2831015</b>	<b>2841015</b>
0.64/0.47	42	c	yes	3	<b>2834308</b>	<b>2834408</b>	-	-
0.64	42	c	no	3	<b>2834309</b>	<b>2834409</b>	-	-
0.72	51	a	yes	3	-	-	<b>2832501</b>	<b>2832601</b>
0.72	51	c	yes	3	-	-	<b>2832503</b>	<b>2832603</b>
0.72	51	d	no	2	-	-	<b>2832504</b>	<b>2832604</b>
0.90	51	a	no	3	-	-	-	<b>2831023</b>
1.10	51	a	no	3	-	-	-	<b>2831027</b>
2.00	51	a	no	2	-	-	-	<b>2831029</b>
<b>HP 7670 - 7672</b>								
0.47	51	a	yes	3	<b>2860307</b>	<b>2860407</b>	-	-
<b>Waters</b>								
0.50	50	b	no	3	<b>2832306</b>	<b>2832406</b>	<b>2832506</b>	<b>2842606</b>
<b>Valco VISF-1</b>								
0.72	19	b	no	3	<b>2833305</b>	<b>2833405</b>	-	<b>2833505</b>
<b>Rheodyne</b>								
0.72	51	b	no	3	<b>2831305</b>	<b>2831405</b>	<b>2831505</b>	<b>2832602</b>
<b>Removable needles for Hamilton syringes</b>								
0.50	50	b	no	3	-	-	<b>21080426</b>	-
0.47	51	a	yes	3	-	-	<b>21775802</b>	-
0.72	51	a	yes	3	-	-	<b>21777003</b>	<b>21777904</b>
0.72	51	b	no	3	-	-	<b>21777001</b>	<b>21777901</b>

We can manufacture needles to your specifications.

# Syringe Needles

## 2. NLL Needles with Metal Luer-Screw

Length: 51 mm  
 Needles: CrNi 1.4301 (AISI SS 304)  
 Luer: Brass, Nickel plated



Gauge	O.D. (mm)	I.D. (mm)	Tip Style a 3 Pack	Tip Style b 3 Pack	Tip Style d 2 Pack
33	0.20	0.11	2840020	2842020	-
32	0.25	0.11	2840025	2842025	-
30	0.30	0.15	2840030	2842030	-
29	0.35	0.15	2840035	2842035	-
27	0.40	0.20	2840040	2842040	-
26	0.45	0.25	2840045	2842045	-
26s	0.47	0.13	2840047	2842047	-
25	0.50	0.28	2840050	2842050	2843050
24	0.55	0.32	2840055	2842055	2843055
23	0.65	0.35	2840065	2842065	2843065
22	0.72	0.41	2840070	2842070	2843070
22s	0.72	0.20	2840072	2842072	-
21	0.80	0.50	2840080	2842080	2843080
20	0.90	0.60	2840090	2842090	2843090
	1.00	0.68	2840100	2842100	2843100
19	1.10	0.80	2840110	2842110	2843110
18	1.30	0.90	2840130	2842130	2843130
17	1.50	1.10	2840150	2842150	2843150
16	1.70	1.20	2840170	2842170	2843170
15	1.80	1.40	2840180	2842180	2843180
	2.00	1.26	2840200	2842200	2843200
13	2.40	1.90	2840240	2842240	2843240
12	2.80	2.20	2840280	2842280	2843280
	3.00	2.06	2840302	2842302	2843302
11	3.00	2.40	2840304	2842304	2843304
10	3.40	2.70	2840340	2842340	2843340

We can manufacture needles to your specifications.



# Syringe Needles

## 3. KNLL Needles with Plastic Luer-Screw

Length: 51 mm  
 Needles: CrNi 1.4301 (AISI SS 304)  
 Luer: Polyvinylidenfluorid (PVDF)



Gauge	O.D. (mm)	I.D. (mm)	Tip Style a 3 Pack	Tip Style b 3 Pack	Tip Style d 2 Pack
33	0.20	0.11	2846020	2849020	-
32	0.25	0.11	2846025	2849025	-
30	0.30	0.15	2846030	2849030	-
29	0.35	0.15	2846035	2849035	-
27	0.40	0.20	2846040	2849040	-
26	0.45	0.25	2846045	2849045	-
26s	0.47	0.13	2846047	2849047	-
25	0.50	0.28	2846050	2849050	2844050
24	0.55	0.32	2846055	2849055	2844055
23	0.65	0.35	2846065	2849065	2844065
22	0.72	0.41	2846070	2849070	2844070
22s	0.72	0.20	2846072	2849072	-
21	0.80	0.50	2846080	2849080	2844080
20	0.90	0.60	2846090	2849090	2844090
	1.00	0.68	2846100	2849100	2844100
19	1.10	0.80	2846110	2849110	2844110
18	1.30	0.90	2846130	2849130	2844130
17	1.50	1.10	2846150	2849150	2844150
16	1.70	1.20	2846170	2849170	2844170
15	1.80	1.40	2846180	2849180	2844180
	2.00	1.26	2846200	2849200	2844200
13	2.40	1.90	2846240	2849240	2844240
12	2.80	2.20	2846280	2849280	2844280
	3.00	2.06	2846302	2849302	2844302
11	3.00	2.40	2846304	2849304	2844304
10	3.40	2.70	2846340	2849340	2844340

We can manufacture needles to your specifications.

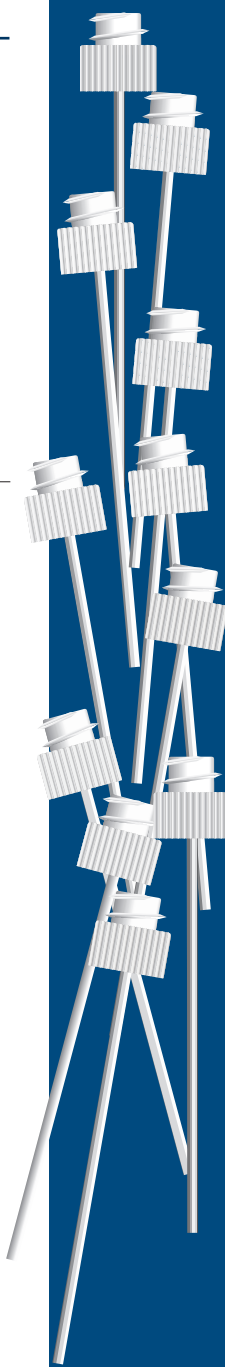

# Dosage of Liquids: Series N

## 1. Fixed Needles (FN)

- Plunger:** Stainless steel  
**Glass Barrel:** Borosilicate 3.3  
**Precision:** <  $\pm 1\%$  of the volume  
**Main Use:**
  - sample dosage for gas chromatography
  - HPLC-valves
  - autosamplers



Volume	Needle Tip Style Length O.D.	fixed a 51 mm	fixed a 70 mm	fixed b 51 mm	fixed c 51 mm	fixed d 51mm
5 $\mu$ l	0.47 mm	2100301	-	2100302	2100303	2100304
10 $\mu$ l	0.47 mm	2100401	2100409	2100402	2100403	2100404
25 $\mu$ l	0.72 mm	2100501	2100509	2100502	2100503	2100504
50 $\mu$ l	0.72 mm	2100601	2100609	2100602	2100603	2100604
100 $\mu$ l	0.72 mm	2100701	2100709	2100702	2100703	2100704
250 $\mu$ l	0.72 mm	2100801	-	2100802	2100803	2100804
500 $\mu$ l	0.72 mm	2100901	-	2100902	2100903	2100904

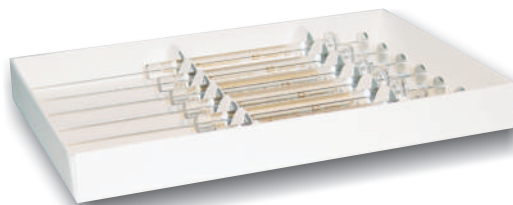

### Six-Pack

Economic pack of 6 syringes,  
fixed needles, length 51 mm  
tip style "a"

Volume	O.D.	2100311	-	-	2100323	-
5 $\mu$ l	0.47 mm	2100311	-	-	2100323	-

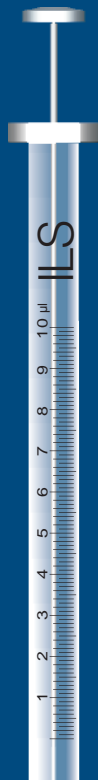

# Dosage of Liquids: Series N

## 2. Fixed Needles (FN), Customized Length, with Guide

**Plunger:** Stainless steel  
**Glass Barrel:** Borosilicate 3.3  
**Precision:** <math>\pm 1\%</math> of the volume  
**Main Use:**

- sample dosage for gas chromatography
- HPLC-valves
- autosamplers

Volume	Needle Tip Style Length O.D.	Special Length of Tip Style a or b or c	fixed Tip Style a 51 mm with Syringe Guide
5 $\mu$ l	0.47 mm	2110300	2170301
10 $\mu$ l	0.47 mm	2110400	2170401
25 $\mu$ l	0.72 mm	2110500	2170501
50 $\mu$ l	0.72 mm	2110600	2170601
100 $\mu$ l	0.72 mm	2110700	2170701
250 $\mu$ l	0.72 mm	2110800	2170801

### Specify with Order

- 1) Length in mm and
- 2) Tip Style

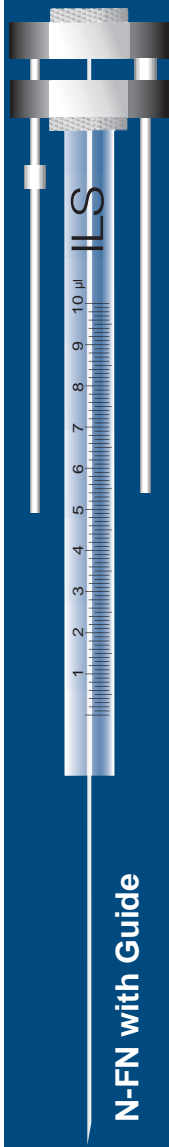
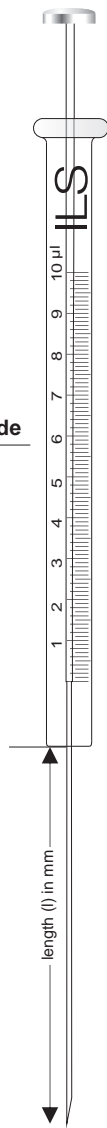
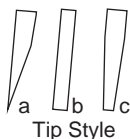

# Dosage of Liquids: Series N

## 3. Removable Needles (RN)

- Plunger:** Stainless steel  
**Glass Barrel:** Borosilicate 3.3  
**Precision:** <  $\pm 1\%$  of the volume  
**Main Use:**
- sample dosage for gas chromatography
  - HPLC-valves
  - autosamplers

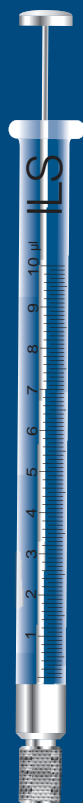

N-RN

Volume	Needle Tip Style Length O.D.	removable a 51 mm	removable b 51 mm
5 µl	0.47 mm	2100305	2100306
10 µl	0.47 mm	2100405	2100406
25 µl	0.72 mm	2100505	2100506
50 µl	0.72 mm	2100605	2100606
100 µl	0.72 mm	2100705	2100706
250 µl	0.72 mm	2100805	2100806
500 µl	0.72 mm	2100905	2100906

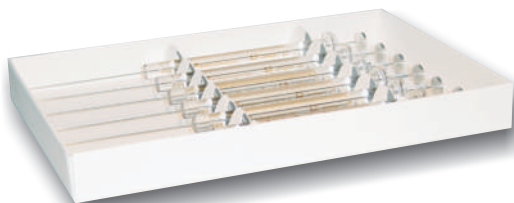

### Six-Pack

Economic pack of 6 syringes,  
removable needles, length 51 mm  
tip style "a"

Volume	O.D.
--------	------

# Dosage of Liquids: Series N

## 4. Removable Needles , Customized Length, with Guide

**Plunger:** Stainless steel  
**Glass Barrel:** Borosilicate 3.3  
**Precision:** <  $\pm 1\%$  of the volume  
**Main Use:**

- sample dosage for gas chromatography
- HPLC-valves
- autosamplers

Volume	Needle Tip Style Length O.D.	Special Length of Tip Style a or b or c	removable a 51 mm with Syringe Guide
5 $\mu\text{l}$	0.47 mm	2110301	2170305
10 $\mu\text{l}$	0.47 mm	2110401	2170405
25 $\mu\text{l}$	0.72 mm	2110501	2170505
50 $\mu\text{l}$	0.72 mm	2110601	2170605
100 $\mu\text{l}$	0.72 mm	2110701	2170705
250 $\mu\text{l}$	0.72 mm	2110801	2170805

**Specify with Order**

- 1) Length in mm and
- 2) Tip Style

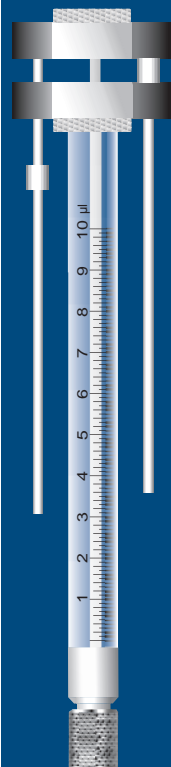
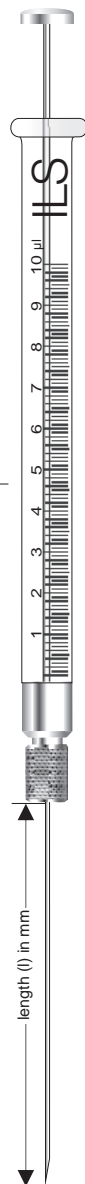
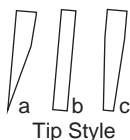

N-RN with Guide

# Dosage of Liquids: Series N

---

## 5. TLL PTFE-Luer-Lock

**Plunger:** Stainless steel  
**Glass Barrel:** Borosilicate 3.3  
**Precision:** <  $\pm 1\%$  of the volume  
**Main Use:**  
- sample dosage  
- dosage of aggressive liquids

---

### Volume

50 $\mu\text{l}$	2100611
100 $\mu\text{l}$	2100711
250 $\mu\text{l}$	2100811

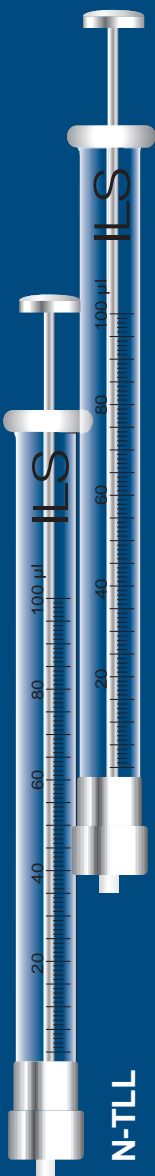

# Dosage of Liquids: Series N

## 6. Super Elastic Plunger - Hi-Res

**Plunger:** Nickel titanium alloy, flexible memory metal  
high resistant, no iron

**Glass Barrel:** Borosilicate 3.3

**Precision:** < ±1% of the volume

**Main Use:**

- sample dosage for gas chromatography
- HPLC-valves
- autosamplers

**Fixed Needles (FN)**



	Tip Style Length O.D.	a 51 mm	b 51 mm	c 51 mm	d 51 mm
Volume					
5 µl	0.47 mm	2160301	2160302	2160303	2160304
10 µl	0.47 mm	2160401	2160402	2160403	2160404

**Removable Needles (RN)**



	Tip Style Length O.D.	a 51 mm	b 51 mm	c 51 mm	d 51 mm
Volume					
5 µl	0.47 mm	2160305	2160306	2160307	2160308
10 µl	0.47 mm	2160405	2160406	2160407	2160408

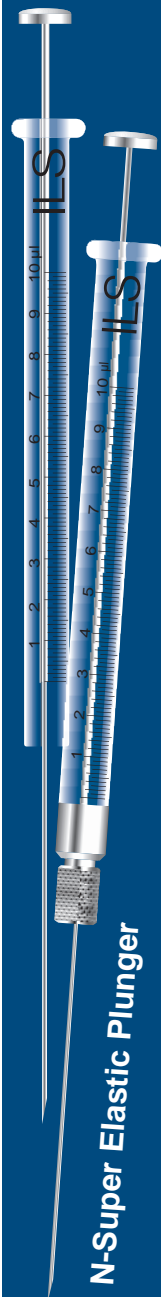



**N-Super Elastic Plunger**

# Dosage of Liquids: Series SN



## 1. With Extended Handle

- Plunger:** Stainless steel  
**Glass Barrel:** Borosilicate 3.3  
**Precision:** <  $\pm 1\%$  of the volume  
**Handle:** - protects the plunger from bending  
- prevents heat transfer from the hand to the contents of the syringe  
**Main Use:** - sample dosage for gas chromatography  
- HPLC-valves

### Fixed Needles (FN)

Volume	Needle Tip Style Length O.D.	 fixed a	 fixed b
		51 mm	51 mm
5 $\mu$ l	0.47 mm	2500301	2500302
10 $\mu$ l	0.47 mm	2500401	2500402
25 $\mu$ l	0.72 mm	2500501	2500502
50 $\mu$ l	0.72 mm	2500601	2500602
100 $\mu$ l	0.72 mm	2500701	2500702
250 $\mu$ l	0.72 mm	2500801	2500802

### Removable Needles (RN)

Volume	Needle Tip Style Length O.D.	 removable a	 removable b
		51 mm	51 mm
5 $\mu$ l	0.47 mm	2500305	2500306
10 $\mu$ l	0.47 mm	2500405	2500406
25 $\mu$ l	0.72 mm	2500505	2500506
50 $\mu$ l	0.72 mm	2500605	2500606
100 $\mu$ l	0.72 mm	2500705	2500706



# Dosage of Liquids: Series SN

## 2. With Extended Handle, Customized Length and Replacement Barrels

- Plunger:** Stainless steel
- Glass Barrel:** Borosilicate 3.3
- Precision:** < ±1% of the volume
- Handle:**
- protects the plunger from bending
  - prevents heat transfer from the hand to the contents of the syringe
- Main Use:**
- sample dosage for gas chromatography
  - HPLC-valves

### Fixed Needle (FN), Special Length with Plunger

Volume	Needle Tip Style Length O.D.	Special Length of Tip Style a or b	Replacement Glass Barrel Tip Style a or b
5 µl	0.47 mm	2510300	2530301
10 µl	0.47 mm	2510400	2530401
25 µl	0.72 mm	2510500	2530501
50 µl	0.72 mm	2510600	2530601
100 µl	0.72 mm	2510700	2530701
250 µl	0.72 mm	2510800	2530801

### Removable Needle (RN), Special Length with Plunger

Volume	Needle Tip Style Length O.D.	Special Length of Tip Style a or b	Replacement Glass Barrel Tip Style a or b
5 µl	0.47 mm	2510305	2530305
10 µl	0.47 mm	2510405	2530405
25 µl	0.72 mm	2510505	2530505
50 µl	0.72 mm	2510605	2530605
100 µl	0.72 mm	2510705	2530705

Specify with Order

- 1) Length in mm and
- 2) Tip Style

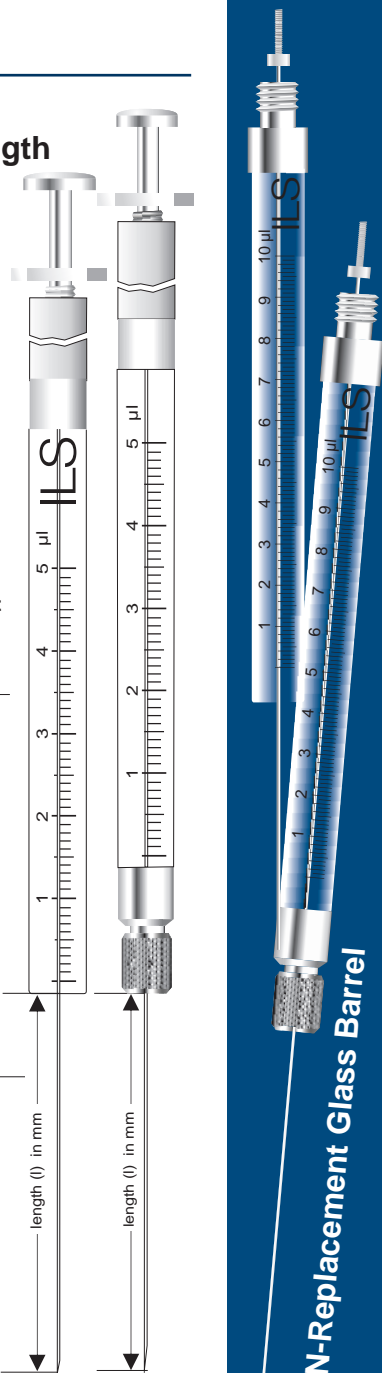
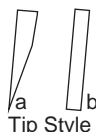

SN-Replacement Glass Barrel

# Dosage of Liquids: Series T

## 1. Zero Dead Volume Syringes

**Plunger:** Stainless steel, plunger runs inside the needle



**Glass Barrel:** Borosilicate 3.3

**Precision:** <  $\pm 1\%$  of the volume

**Main Use:**

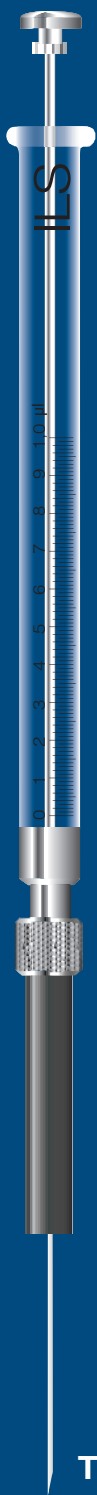
- sample dosage for gas chromatography
- dosage of small amounts of liquids
- for Thin Layer Chromatography (TLC)



Volume	Tip Style Length O.D.			
		a 70 mm	b 70 mm	d 70 mm
0.5 $\mu\text{l}$	0.47 mm	2200051	2200055	-
1 $\mu\text{l}$	0.47 mm	2200101	2200102	2200103
2 $\mu\text{l}$	0.72 mm	2200201	2200202	2200203
5 $\mu\text{l}$	0.55 mm	2200301	2200302	2200303
10 $\mu\text{l}$	0.70 mm	2200401	2200402	2200403
25 $\mu\text{l}$	1.10 mm	2200501	2200502	2200503

# Dosage of Liquids: Series T

---

## 2. Replacement Parts

- Plunger:** Stainless steel, plunger runs inside the needle
- Glass Barrel:** Borosilicate 3.3
- Precision:** < ±1% of the volume
- Main Use:**
- sample dosage for gas chromatography
  - dosage of small amounts of liquids
  - for Thin Layer Chromatography (TLC)

### Replacement Kit

Includes 1 needle and 1 calibrated plunger



**a**  
70 mm  
Needle/  
Plunger



**b**  
70 mm  
Needle/  
Plunger

Volume	Tip Style Length O.D.		
1 µl	0.47 mm	2231101	2231102
2 µl	0.72 mm	2231201	2231202
5 µl	0.55 mm	2231301	2231302
10 µl	0.70 mm	2231401	2231402
25 µl	1.10 mm	2231501	2231502

### Sealing Kit

Includes 5 seals

Volume	O.D.	
1 µl	0.47 mm	2230001
2 µl	0.72 mm	2230002
5 µl	0.55 mm	2230003
10 µl	0.70 mm	2230004

# Dosage of Gas and Liquids: Series H

## 1. Fixed Needles (FN)

**Plunger:** Stainless steel with PTFE-seal

**Glass Barrel:** Borosilicate 3.3

**Precision:** <  $\pm 1\%$  of the volume

**Main Use:**

- sample dosage for gas chromatography
- HPLC-valves
- autosamplers
- dosage of aggressive fluids

Volume	Needle Tip Style Length O.D.	fixed	fixed	fixed
		a 51 mm	b 51 mm	d 51 mm
5 $\mu$ l	0.47 mm	2600301	2600302	2600304
10 $\mu$ l	0.47 mm	2600401	2600402	2600404
25 $\mu$ l	0.72 mm	2600501	2600502	2600504
50 $\mu$ l	0.72 mm	2600601	2600602	2600604
100 $\mu$ l	0.72 mm	2600701	2600702	2600704
250 $\mu$ l	0.72 mm	2600801	2600802	2600804
500 $\mu$ l	0.72 mm	2600901	2600902	2600904
1.0 ml	0.72 mm	2600000	2600001	2600002
2.5 ml	0.72 mm	2600020	2600021	2600022
5.0 ml	0.72 mm	2600040	2600041	2600042
10.0 ml	0.72 mm	2600060	2600061	2600062

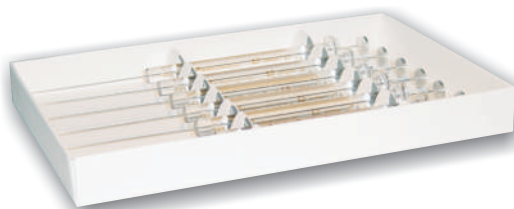

### Six-Pack

Economic pack of 6 syringes,  
fixed needles, length 51 mm  
tip style "a"

Volume	O.D.			
5 $\mu$ l	0.47 mm	2600311	-	-
10 $\mu$ l	0.47 mm	2600411	-	-

# Dosage of Gas and Liquids: Series H

## 2. Fixed Needles, Customized Length

- Plunger:** Stainless steel with PTFE-seal  
**Glass Barrel:** Borosilicate 3.3  
**Precision:** <math>\pm 1\%</math> of the volume  
**Main Use:**
  - sample dosage for gas chromatography
  - HPLC-valves
  - autosamplers
  - dosage of aggressive fluids

Volume	Needle Tip Style Length O.D.	Special Length of Tip Style a or b or c
5 $\mu$ l	0.47 mm	2610300
10 $\mu$ l	0.47 mm	2610400
25 $\mu$ l	0.72 mm	2610500
50 $\mu$ l	0.72 mm	2610600
100 $\mu$ l	0.72 mm	2610700
250 $\mu$ l	0.72 mm	2610800
500 $\mu$ l	0.72 mm	2610900
1.0 ml	0.72 mm	2610000
2.5 ml	0.72 mm </td <td>2610020</td>	2610020
5.0 ml	0.72 mm	2610040
10.0 ml	0.72 mm	2610060

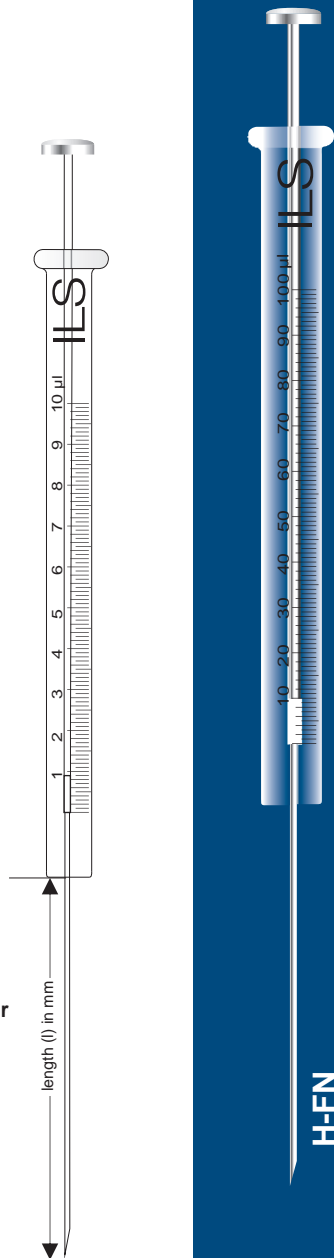

# Dosage of Gas and Liquids: Series H

## 3. Removable Needles (RN)

- Plunger:** Stainless steel with PTFE-seal
- Glass Barrel:** Borosilicate 3.3
- Precision:** <  $\pm 1\%$  of the volume
- Main Use:**
- sample dosage for gas chromatography
  - HPLC-valves
  - autosamplers
  - dosage of aggressive fluids

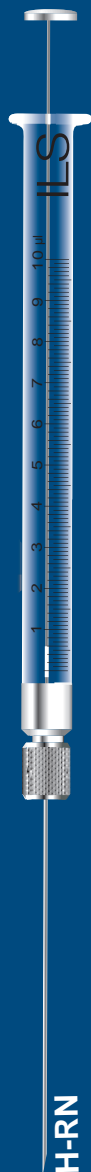

Volume	Needle Tip Style Length O.D.	removable a 51 mm	removable b 51 mm	removable d 51 mm
5 µl	0.47 mm	2600305	2600306	2600308
10 µl	0.47 mm	2600405	2600406	2600408
25 µl	0.72 mm	2600505	2600506	2600508
50 µl	0.72 mm	2600605	2600606	2600608
100 µl	0.72 mm	2600705	2600706	2600708
250 µl	0.72 mm	2600805	2600806	2600808
500 µl	0.72 mm	2600905	2600906	2600908
1.0 ml	0.72 mm	2600005	2600006	2600007
2.5 ml	0.72 mm	2600025	2600026	2600027
5.0 ml	0.72 mm	2600045	2600046	2600047
10.0 ml	0.72 mm	2600065	2600066	-

# Dosage of Gas and Liquids: Series H

## 4. Removable Needles (RN), Customized Length

- Plunger:** Stainless steel with PTFE-seal  
**Glass Barrel:** Borosilicate 3.3  
**Precision:** <math>\pm 1\%</math> of the volume  
**Main Use:**
  - sample dosage for gas chromatography
  - HPLC-valves
  - autosamplers
  - dosage of aggressive fluids

Volume	Needle Tip Style Length O.D.	Special Length of Tip Style a or b
5 $\mu$ l	0.47 mm	2610309
10 $\mu$ l	0.47 mm	2610409
25 $\mu$ l	0.72 mm	2610509
50 $\mu$ l	0.72 mm	2610609
100 $\mu$ l	0.72 mm	2610709
250 $\mu$ l	0.72 mm	2610809
500 $\mu$ l	0.72 mm	2610909
1.0 ml	0.72 mm	2610007
2.5 ml	0.72 mm	2610027
5.0 ml	0.72 mm	2610047
10.0 ml	0.72 mm	2610067

### Specify with Order

- 1) Length in mm  
and
- 2) Tip Style

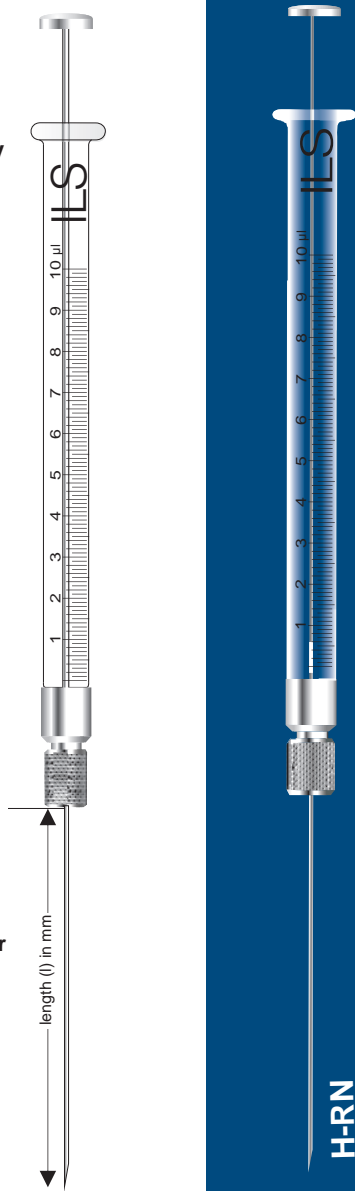
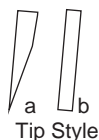

# Dosage of Gas and Liquids: Series H

---

## 5. LT Glass-Luer-Tip without Needle

**Plunger:** Stainless steel with PTFE-seal

**Glass Barrel:** Borosilicate 3.3

**Precision:** <  $\pm 1\%$  of the volume

**Main Use:**

- sample dosage
- dosage of aggressive fluids
- can be autoclaved

---

### Volume

5 $\mu\text{l}$	2600314
10 $\mu\text{l}$	2600412
25 $\mu\text{l}$	2600511
50 $\mu\text{l}$	2600611
100 $\mu\text{l}$	2600711
250 $\mu\text{l}$	2600811
500 $\mu\text{l}$	2600911
1.0 ml	2600013
2.5 ml	2600033
5.0 ml	2600053

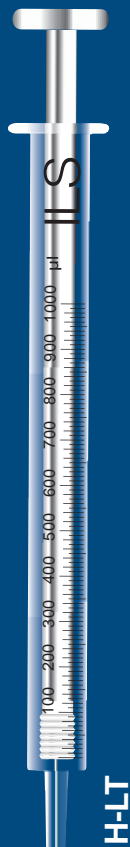



# Dosage of Gas and Liquids: Series H

---

## 6. TLT PTFE-Luer-Tip without Needle

**Plunger:** Stainless steel with PTFE-seal  
**Glass Barrel:** Borosilicate 3.3  
**Precision:** <  $\pm 1\%$  of the volume  
**Main Use:**  
- sample dosage  
- dosage of aggressive liquids

### Volume

---

5 $\mu$ l	2600313
10 $\mu$ l	2600413
25 $\mu$ l	2600513
50 $\mu$ l	2600613
100 $\mu$ l	2600713
250 $\mu$ l	2600813
500 $\mu$ l	2600913
1.0 ml	2600014
2.5 ml	2600034
5.0 ml	2600054

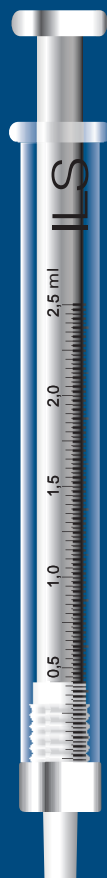

H-TLT

# Dosage of Gas and Liquids: Series SH

## 1. With Extended Handle

- Plunger:** PTFE-seal  
**Glass Barrel:** Borosilicate 3.3  
**Precision:** <  $\pm 1\%$  of the volume  
**Handle:**
  - protects the plunger from bending
  - prevents heat transfer from the hand to the contents
- Main Use:**
  - sample dosage for gas chromatography
  - HPLC-valves

### Fixed Needle(FN)

Volume	Needle Tip Style Length O.D.	fixed a 51 mm	fixed b 51 mm
5 $\mu\text{l}$	0.47 mm	2506301	2506302
10 $\mu\text{l}$	0.47 mm	2506401	2506402
25 $\mu\text{l}$	0.72 mm	2506501	2506502
50 $\mu\text{l}$	0.72 mm	2506601	2506602
100 $\mu\text{l}$	0.72 mm	2506701	2506702
250 $\mu\text{l}$	0.72 mm	2506801	2506802

### Removable Needle(RN)

Volume	Needle Tip Style Length O.D.	a 51 mm	b 51 mm
5 $\mu\text{l}$	0.47 mm	2506305	2506306
10 $\mu\text{l}$	0.47 mm	2506405	2506406
25 $\mu\text{l}$	0.72 mm	2506505	2506506
50 $\mu\text{l}$	0.72 mm	2506605	2506606
100 $\mu\text{l}$	0.72 mm	2506705	2506706



# Dosage of Gas and Liquids: Series SH

## 2. With Extended Handle, Customized Length and Replacement Barrels

- Plunger:** PTFE-seal  
**Glass Barrel:** Borosilicate 3.3  
**Precision:** <  $\pm 1\%$  of the volume  
**Handle:**
  - protects the plunger from bending
  - prevents heat transfer from the hand to the contents of the syringe**Main Use:**
  - sample dosage for gas chromatography
  - HPLC-valves

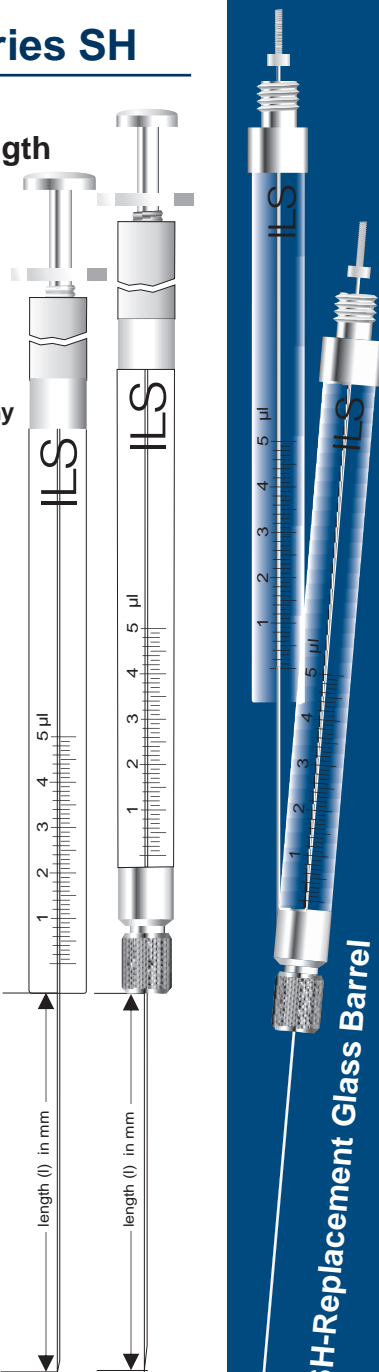

### Fixed Needle(FN), Special Length with Plunger

Volume	Needle Tip Style Length O.D.	Special Length of Tip Style a or b	Replacement Glass Barrels Tip Style a or b
5 µl	0.47 mm	2516301	2536301
10 µl	0.47 mm	2516401	2536401
25 µl	0.72 mm	2516501	2536501
50 µl	0.72 mm	2516601	2536601
100 µl	0.72 mm	2516701	2536701
250 µl	0.72 mm	2516801	2536801

### Removable Needle (RN), Special Length with Plunger

Volume	Needle Tip Style Length O.D.	Special Length of Tip Style a or b	Replacement Glass Barrel Tip Style a or b
5 µl	0.47 mm	2516302	2536305
10 µl	0.47 mm	2516402	2536405
25 µl	0.72 mm	2516502	2536505
50 µl	0.72 mm	2516602	2536605
100 µl	0.72 mm	2516702	2536705
250 µl	0.72 mm	2516802	2536805

Specify with Order

- 1) Length in mm and
- 2) Tip Style



SH-Replacement Glass Barrel

# Dosage of Gas and Liquids: Series H

---

## 7. TLL PTFE-Luer-Lock

**Plunger:** PTFE-seal  
**Glass Barrel:** Borosilicate 3.3  
**Precision:** <  $\pm 1\%$  of the volume  
**Main Use:**  
- sample dosage  
- dosage of aggressive liquids

---

### Volume

5 $\mu$ l	2600309
10 $\mu$ l	2600409
25 $\mu$ l	2607509
50 $\mu$ l	2607609
100 $\mu$ l	2607709
250 $\mu$ l	2607809
500 $\mu$ l	2607909
1.0 ml	2607011
2.5 ml	2607031
5.0 ml	2607051
10.0 ml	2607071
25.0 ml	2607091
50.0 ml	2607101
100.0 ml	2607121



H-TLL

# Dosage of Gas and Liquids: Series G

## With Static PTFE-Seal Topping the Glass Barrel

- Plunger:** Stainless steel  
**Glass Barrel:** Borosilicate 3.3  
**Precision:**  $< \pm 1\%$  of the volume  
**Seal:** PTFE-seal at the end of glass barrel  
**Main Use:**
  - sample dosage for gas chromatography
  - HPLC-valves
  - dosage with counter-pressure

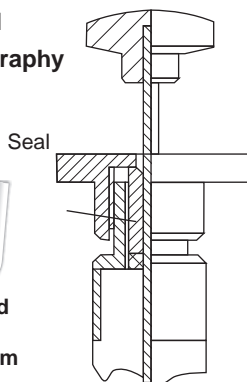

### Fixed Needles (FN)

Volume	Needle Tip Style Length O.D.	fixed a	fixed b	fixed d
		51 mm	51 mm	51 mm
10 µl	0.47 mm	2400401	2400402	2400404
25 µl	0.72 mm	2400501	2400502	2400504
50 µl	0.72 mm	2400601	2400602	2400604
100 µl	0.72 mm	2400701	2400702	2400704
250 µl	0.72 mm	2400801	2400802	2400804
500 µl	0.72 mm	2400901	2400902	2400904

### Removable Needles (RN)

Volume	Needle Tip Style Length O.D.	removable a	removable b	removable d
		51 mm	51 mm	51 mm
10 µl	0.47 mm	2400405	2400406	2400408
25 µl	0.72 mm	2400505	2400506	2400508
50 µl	0.72 mm	2400605	2400606	2400608
100 µl	0.72 mm	2400705	2400706	2400708
250 µl	0.72 mm	2400805	2400806	2400808

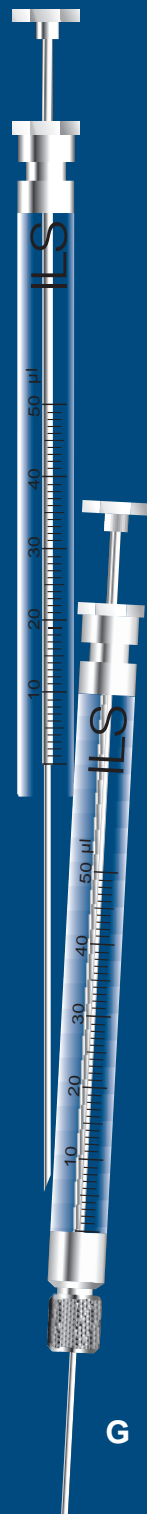

# Dosage of Gas and Liquids: Series P

## 1. With Adjustable PTFE-seal

- Plunger:** Adjustable PTFE-seal on the plunger  
**Glass Barrel:** Borosilicate 3.3  
**Precision:** <  $\pm 1\%$  of the volume  
**Main Use:**
  - sample dosage for gas chromatography
  - HPLC-valves
  - dosage with counter-pressure

### Fixed Needles (FN)

Volume	Tip Style Length O.D.				
		a 51 mm	b 51 mm	c 51 mm	d 51 mm
25 $\mu\text{l}$	0.72 mm	2300501	2300502	2300503	2300504
50 $\mu\text{l}$	0.72 mm	2300601	2300602	2300603	2300604
100 $\mu\text{l}$	0.72 mm	2300701	2300702	2300703	2300704
250 $\mu\text{l}$	0.72 mm	2300801	2300802	2300803	2300804
500 $\mu\text{l}$	0.72 mm	2300901	2300902	2300903	2300904

### Removable Needles (RN)

Volume	Tip Style Length O.D.				
		a 51 mm	b 51 mm	c 51 mm	d 51 mm
25 $\mu\text{l}$	0.72 mm	2300505	2300506	2300507	2300508
50 $\mu\text{l}$	0.72 mm	2300605	2300606	2300607	2300608
100 $\mu\text{l}$	0.72 mm	2300705	2300706	2300707	2300708
250 $\mu\text{l}$	0.72 mm	2300805	2300806	2300807	2300808

# Dosage of Gas and Liquids: Series P

## 2. With Adjustable PTFE-seal, Customized Length

- Plunger:** Adjustable PTFE-seal on the plunger  
**Glass Barrel:** Borosilicate 3.3  
**Precision:** <  $\pm 1\%$  of the volume  
**Main Use:**
- sample dosage for gas chromatography
  - HPLC-valves
  - dosage under pressure

### Fixed Needles (FN)

Volume	Needle Tip Style Length O.D.	Special Length Tip Style a or b or c
25 $\mu\text{l}$	0.72 mm	2310500
50 $\mu\text{l}$	0.72 mm	2310600
100 $\mu\text{l}$	0.72 mm	2310700
250 $\mu\text{l}$	0.72 mm	2310800
500 $\mu\text{l}$	0.72 mm	2310900

### Removable Needles (RN)

Volume	Needle Tip Style Length O.D.	Special needle Tip Style a or b or c
25 $\mu\text{l}$	0.72 mm	2310501
50 $\mu\text{l}$	0.72 mm	2310601
100 $\mu\text{l}$	0.72 mm	2310701
250 $\mu\text{l}$	0.72 mm	2310801

Specify with Order

- 1) Length in mm and
- 2) Tip Style

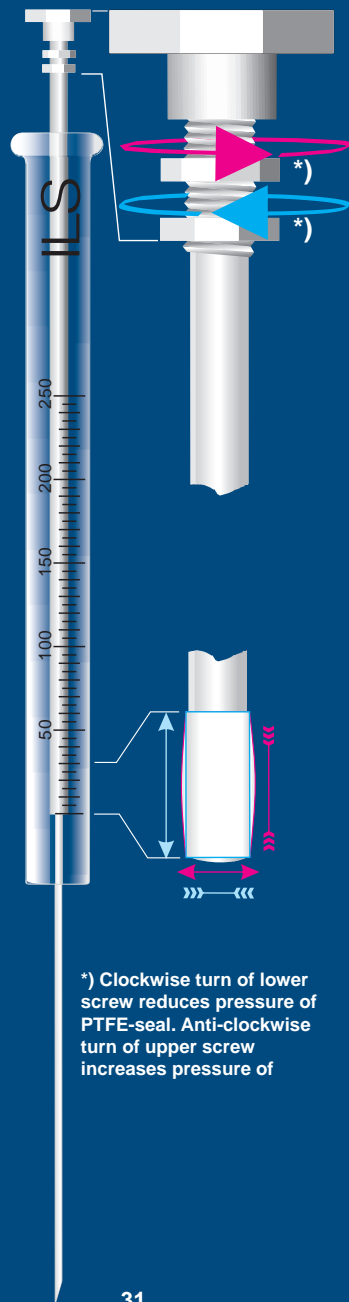
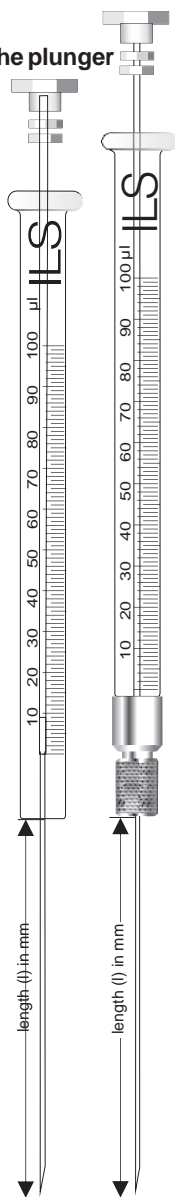
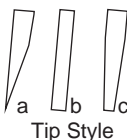



\*) Clockwise turn of lower screw reduces pressure of PTFE-seal. Anti-clockwise turn of upper screw increases pressure of

# Syringes for Headspace Analysis

Glass Barrel: Borosilicate 3.3  
Precision: <math>\pm 1\%</math> of the volume

## Stainless steel with PTFE-seal



Volume	Tip Style Length O.D.	d 51 mm
1.0 ml	0.72 mm	2600002
2.5 ml	0.72 mm	2600022
5.0 ml	0.72 mm	2600042

## Plunger with adjustable PTFE-seal



Volume	Tip Style Length O.D.	d 51 mm
50 $\mu$ l	0.72 mm	2300604
100 $\mu$ l	0.72 mm	2300704
250 $\mu$ l	0.72 mm	2300804

Headspace Analysis



# Syringes for On-Column Injection

**Glass Barrel:** Borosilicate 3.3  
**Precision:** < ±1% of the volume  
**Needles:** Stainless steel (ss), fused silica

## Fixed Needles (FN)

Material	ss	ss
Tip Style	45°	45°
Length	75 mm	85 mm

Volume

O.D.

## Special stainless steel plunger

5 µl	0.23 mm	2142306	2142307
------	---------	---------	---------

## Removable Needles (RN)

Material	ss	ss	ss	ss	fused silica
Tip Style	45°	45°	45°	b	b
Length	75 mm	85 mm	100 mm	125 mm	100 mm

Volume

O.D.

## Special stainless steel plunger

5 µl	0.17 mm	-	-	-	-	2142303
5 µl	0.23 mm	2142313	-	2142312	-	2142304
10 µl	0.17 mm	-	-	-	2142403	-
10 µl	0.23 mm	2142407	2142408	2142412	2142406	2142404

## With PTFE-plunger tip

10 µl	0.17 mm	-	-	-	-	2642401
10 µl	0.23 mm	-	-	-	-	2642402

## Replacement Needles

Material	ss	ss	ss	ss	fused silica
Tip Style	45°	45°	45°	b	b
Length	85 mm	75 mm	100 mm	125 mm	100 mm

Volume

O.D.

		3 Pack	3 Pack	3 Pack	3 Pack	3 Pack
5 µl	0.17 mm	-	-	-	-	2822021
5 µl	0.23 mm	2822304	2822303	2822302	-	-
10 µl	0.17 mm	-	-	-	-	2822022



On-Column Injection

# Syringes for GC Autosampler

## 1. Agilent Technologies (HP) 7670/7671/7672

Glass Barrel: Borosilicate 3.3  
 Precision: <math>\lt; \pm 1\% \text{ of the volume}</math>

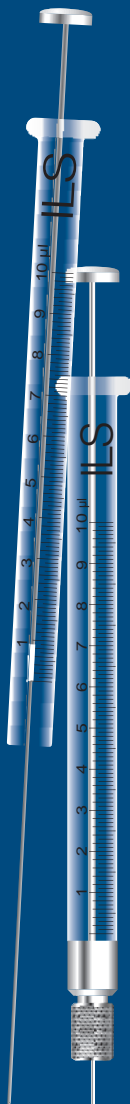

fixed  
a  
51 mm



removable  
a  
51 mm

Volume	Needle Tip Style Length O.D.	fixed a 51 mm	removable a 51 mm
<b>Flexible plunger</b>			
5 $\mu\text{l}$	0.47 mm	2160301	2160305
10 $\mu\text{l}$	0.47 mm	2160401	2160405
<b>Special stainless steel plunger</b>			
5 $\mu\text{l}$	0.47 mm	2100301	2100305
10 $\mu\text{l}$	0.47 mm	2100401	2100405
<b>Special stainless steel plunger with PTFE-seal</b>			
10 $\mu\text{l}$	0.47 mm	2600401	2600405

### Six-Pack

Economic pack of 6 syringes,  
 fixed needles, length 51 mm  
 tip style "a"

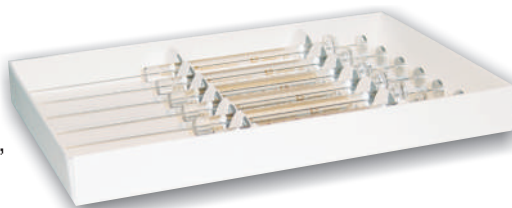

Volume	O.D.
<b>Special stainless steel plunger</b>	

# Syringes for GC Autosampler

## 2. Agilent Technologies (HP) 7673 - 7683

Glass Barrel: Borosilicate 3.3  
 Precision : <math>\pm 1\%</math> of the volume

### Fixed Needles (FN)

Volume	Tip Style Length O.D.	42 mm		42 mm		42 mm		42 mm		
		C	C	C	C	C	C	C	C	
			Six-Pack*		Six-Pack*				SixPack*	
<b>Zero dead volume (plunger in needle)</b>										
0,5 µl	0,47mm	2204051	-	-	-	-	-	-	-	
0,5 µl	0,64mm	-	-	-	-	-	2204052	-	-	
1,0 µl	0,47 mm	2204104	-	-	-	-	-	-	-	
1,0 µl	0,64mm	-	-	-	-	-	2204103	-	-	
<b>Flexible plunger - Hi-Res</b>										
5 µl	0.47 mm	2164303	2164313	-	-	-	-	-	-	
10 µl	0.47 mm	2164403	2164413	-	-	-	-	-	-	
5 µl	0.47/0.64 mm	-	-	2164304	2164314	-	-	-	-	
10 µl	0.47/0.64 mm	-	-	2164404	2164414	-	-	-	-	
5 µl	0.64 mm	-	-	-	-	-	2164305	2164315	-	
10 µl	0.64 mm	-	-	-	-	-	2164405	2164415	-	
<b>Special stainless steel plunger</b>										
5 µl	0.47 mm	2104303	2104313	-	-	-	-	-	-	
10 µl	0.47 mm	2104403	2104413	-	-	-	-	-	-	
5 µl	0.47/0.64 mm	-	-	2104304	2104314	-	-	-	-	
10 µl	0.47/0.64 mm	-	-	2104404	2104414	-	-	-	-	
5 µl	0.64 mm	-	-	-	-	-	2104305	2104315	-	
10 µl	0.64 mm	-	-	-	-	-	2104405	2104415	-	
25 µl	0.64 mm	-	-	-	-	-	2104505	-	-	
50 µl	0.64 mm	-	-	-	-	-	2104605	-	-	
100 µl	0.64 mm	-	-	-	-	-	2104705	-	-	
<b>Special stainless steel plunger with PTFE-seal</b>										
5 µl	0.47 mm	2604303	2604313	-	-	-	-	-	-	
10 µl	0.47 mm	2604403	2604413	-	-	-	-	-	-	
5 µl	0.47/0.64 mm	-	-	2604304	2604314	-	-	-	-	
10 µl	0.47/0.64 mm	-	-	2604404	2604414	-	-	-	-	
5 µl	0.64 mm	-	-	-	-	-	2604305	2604315	-	
10 µl	0.64 mm	-	-	-	-	-	2604405	2604415	-	
25 µl	0.64 mm	-	-	-	-	-	2604505	-	-	
50 µl	0.64 mm	-	-	-	-	-	2604605	-	-	
100 µl	0.64 mm	-	-	-	-	-	2604705	-	-	

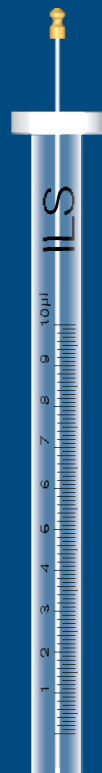

Agilent

# Syringes for GC Autosampler

## Agilent Technologies (HP) 7673 - 7683, 6850

### A-Syringe™

- Longer lifetime
- Gastight, with static PTFE-Seal topping the glass barrel
- Straight guided plunger

**Glass Barrel:** Borosilicate 3.3  
**Precision :** < ±1% of the volume

#### Fixed Needles(FN)

Volume	Tip Style Length O.D.	42 mm		42 mm		42 mm	
		C	C	C	C	C	C
			Six-Pack*		Six-Pack*		Six-Pack*
<b>Flexible plunger - Hi-Res</b>							
5 µl	0.47 mm	2164333	2164336	-	-	-	-
10 µl	0.47 mm	2164433	2164436	-	-	-	-
5 µl	0.47/0.64 mm	-	-	2164337	2164338	-	-
10 µl	0.47/0.64 mm	-	-	2164434	2164438	-	-
5 µl	0.64 mm	-	-	-	-	2164339	2164340
10 µl	0.64 mm	-	-	-	-	2164435	2164437
<b>Special stainless steel plunger</b>							
5 µl	0.47 mm	2104333	2104337	-	-	-	-
10 µl	0.47 mm	2104433	2104437	-	-	-	-
5 µl	0.47/0.64 mm	-	-	2104334	2104338	-	-
10 µl	0.47/0.64 mm	-	-	2104434	2104438	-	-
5 µl	0.64 mm	-	-	-	-	2104335	2104336
10 µl	0.64 mm	-	-	-	-	2104435	2104436

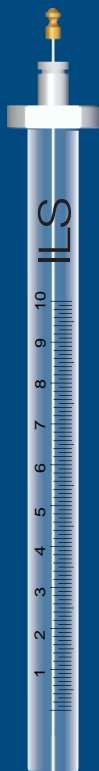

Agilent A - Syringe™

# Syringes for GC Autosampler

## Agilent Technologies (HP) 7673 - 7683

Glass Barrel: Borosilicate 3.3  
 Precision : <math>\pm 1\%</math> of the volume

### Removable Needles (RN)

Volume	Tip Style Length O.D.	 C 42 mm	 C 42 mm	 C 42 mm
--------	-----------------------------	--	--	--

### Flexible plunger - Hi-Res

5 $\mu$ l	0.47 mm	2164307	-	-
10 $\mu$ l	0.47 mm	2164407	-	-
5 $\mu$ l	0.47/0.64 mm	-	2164308	-
10 $\mu$ l	0.47/0.64 mm	-	2164408	-
5 $\mu$ l	0.64 mm	-	-	2164309
10 $\mu$ l	0.64 mm	-	-	2164409

### Special stainless steel plunger

5 $\mu$ l	0.47 mm	2104307	-	-
10 $\mu$ l	0.47 mm	2104407	-	-
5 $\mu$ l	0.47/0.64 mm	-	2104308	-
10 $\mu$ l	0.47/0.64 mm	-	2104408	-
5 $\mu$ l	0.64 mm	-	-	2104309
10 $\mu$ l	0.64 mm	-	-	2104409

### Special stainless steel plunger with PTFE-seal

5 $\mu$ l	0.47 mm	2604307	-	-
10 $\mu$ l	0.47 mm	2604407	-	-
5 $\mu$ l	0.47/0.64 mm	-	2604308	-
10 $\mu$ l	0.47/0.64 mm	-	2604408	-
5 $\mu$ l	0.64 mm	-	-	2604309

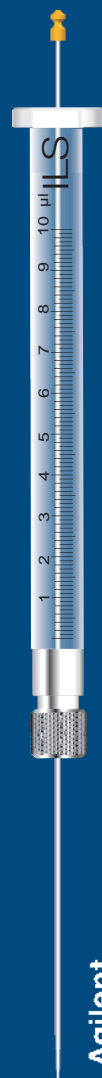

Agilent

# Syringes for GC Autosampler

## 3. LEAP Technologies, CTC, Carlo Erba, Finsons

Glass Barrel: Borosilicate 3.3  
 Precision : <math>\pm 1\%</math> of the volume

### CTC A200 S/ A200 SE/ A800/ GC PAL/ Combi PAL



Volume	Glass barrel O.D. mm	Series	Gauge	Needle Tip Style Length O.D.mm	fixed a 51 mm	fixed c 51 mm	fixed c 80 mm	fixed c 51 mm 6-Pack
<b>Zero dead volume (plunger in needle)</b>								
1.2 µl	6.5	T	26P	0.47	-	2220001	-	-
<b>Flexible plunger - Hi-Res</b>								
5 µl	6.5	N	26s	0.47	2166301	-	-	-
10 µl	6.5	N	26s	0.47	2166401	-	-	-
10 µl	6.5	A	26s	0.47	2166402	-	-	2166434
<b>Special stainless steel plunger</b>								
5 µl	6.5	N	26s	0.47	2106301	2106302	-	-
5 µl	6.5	A	26s	0.47	2106334	2106333	-	2106337
5 µl	6.5	A	23s	0.64	-	2106335	-	2106338
10 µl	6.5	N	26s	0.47	2106401	2106416	-	2106425
10 µl	6.5	A	26s	0.47	2106439	2106433	2106420	2106436
10 µl	6.5	N	23s	0.64	2106422	2106403	2106413	2106419
10 µl	6.5	A	23s	0.64	-	2106451	2106438	2106449
10 µl	6.5	N	22s	0.72	-	-	2106415	-
<b>Special stainless steel plunger with PTFE-seal</b>								
10 µl	6.5	H	26s	0.47	2606401	2606407	-	-
10 µl	6.5	H	23s	0.64	2606409	2606403	2606406	-
25 µl	6.5	H	26s	0.47	-	2620506	-	-
25 µl	6.5	H	23s	0.64	-	2620503	2620512	-
50 µl	6.5	H	26s	0.47	-	2620606	-	-
50 µl	6.5	H	23s	0.64	-	2620603	2620612	-
100 µl	6.5	H	26s	0.47	-	2620706	-	-
100 µl	6.5	H	23s	0.64	-	2620703	2620712	-
250 µl	7.8	H	26s	0.47	-	2620803	-	-
250 µl	6.5	H	23	0.64	-	2620809	2620812	-
500 µl	7.8	H	26s	0.47	-	2620903	-	-
500 µl	6.5	H	23	0.64	-	2620909	2620906	-

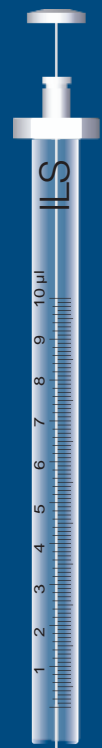

A-Syringe™

# Syringes for GC Autosampler

## 4. Shimadzu AOC 14/17/20

Glass Barrel: Borosilicate 3.3  
 Precision : < ±1% of the volume

### AOC 14/17/20



Series	Needle Tip Style	fixed a	6-Pack a	fixed c	6-Pack c	removable a	removable c
	Length	42 mm	42 mm	42 mm	42 mm	42 mm	42 mm
Volume	O.D.						

### Flexible plunger - Hi-Res

5 µl N	0.47 mm	2165301	-	-	-	2165307	-
5 µl A	0.47 mm	-	-	2165320	2165340	-	-
5 µl N	0.64 mm	2165302	-	2165304	-	-	-
10 µl N	0.47 mm	2165401	-	-	-	2165407	-
10 µl A	0.47 mm	2165417	-	-	-	-	-
10 µl N	0.64 mm	2165402	-	-	-	2165408	-
10 µl A	0.64 mm	2165418	-	2165421	-	-	-

### Special stainless steel plunger

5 µl N	0.47 mm	2105301	-	2105303	-	2105307	-
5 µl A	0.47 mm	2105317	2105336	2105319	2105338	-	-
5 µl N	0.64 mm	2105302	-	2105304	-	2105308	-
5 µl A	0.64 mm	2105318	2105337	2105321	2105339	-	-
10 µl N	0.47 mm	2105401	-	2105403	-	2105407	2105409
10 µl A	0.47 mm	2105417	2105436	2105419	2105438	2105427	2105429
10 µl N	0.64 mm	2105402	2105412	2105404	2105414	2105408	2105410
10 µl A	0.64 mm	2105418	2105437	2105421	2105439	2105428	2105430

### Special stainless steel plunger with PTFE-seal

10 µl H	0.47 mm	2605401	-	2605403	-	2605407	-
10 µl H	0.64 mm	2605402	-	2605404	-	2605408	2605410

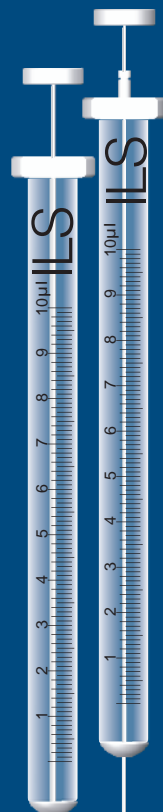

N-Series

A-Syringe™

# Syringes for GC Autosampler

## 5. Perkin Elmer

Glass Barrel: Borosilicate 3.3  
Precision:  $< \pm 1\%$  of the volume

AS 100/AS 2000, AS 3000 GC Autosystems



Volume	Needle Tip Style Length O.D.	fixed c 70 mm
--------	---------------------------------------	---------------------

### Special stainless steel plunger

5 $\mu$ l	0.47 mm	2108302
5 $\mu$ l	0.63 mm	2108303

### Special stainless steel plunger with PTFE-seal

5 $\mu$ l	0.47 mm	2608302
5 $\mu$ l	0.63 mm	2608303

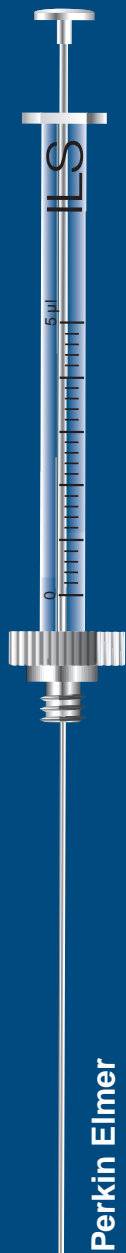

Perkin Elmer



# Syringes for GC Headspace Sampling

## ThermoQuest, Thermo Finnigan, CTC, LEAP, DANI ALS

Glass Barrel: Borosilicate 3.3  
 Precision: < ±1% of the volume

ThermoQuest OC 516/ HS 250/ HS 500

CTC PAL

Glass Barrel: with hole

Volume	Needle Tip Style Length O.D.	fixed d 51 mm	fixed d 56 mm	without
<b>Special stainless steel plunger with PTFE-seal</b>				
1.0 ml	0.47 mm		2620014	-
2.5 ml	0.47 mm	2620040	2620034	-
5.0 ml	0.47 mm		2620051	-
1.0 ml	0.64 mm		2620012	-
2.5 ml	0.64 mm		2620032	-
5.0 ml	0.64 mm		2620050	-
1.0 ml	0.72 mm		2620013	-
2.5 ml	0.72 mm	2620024	2620023	2620028
5.0 ml	0.72 mm		2620049	-

ALS 104, ALS 3841

Volume	Needle Tip Style Length O.D.	fixed d 51 mm	removable d 51 mm
<b>Special stainless steel with PTFE-seal</b>			
10 µl	0.64 mm	2607404	2607408
<b>Special stainless steel plunger</b>			
10 µl	0.64 mm	2107404	2107408

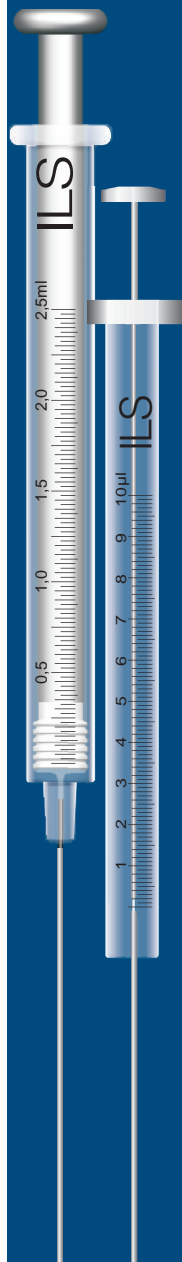

# HPLC Syringes

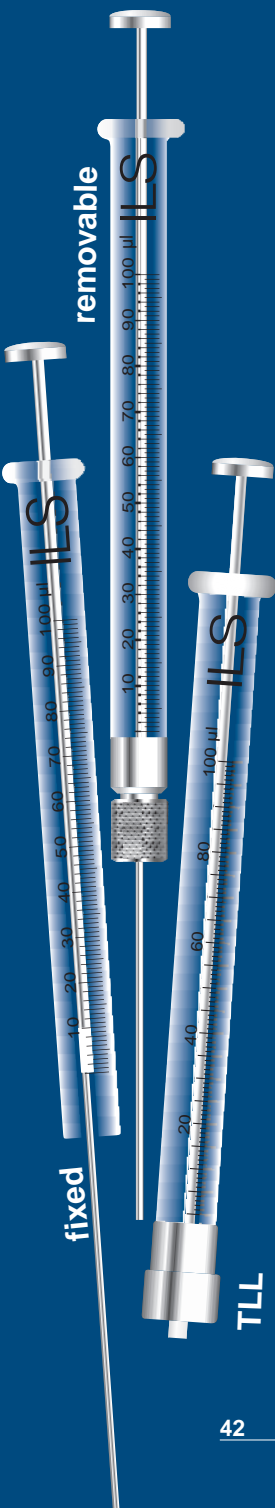

## 1. Most Common Valves

Rheodyne, Varian, Shimadzu, Knauer, Hewlett Packard/  
Agilent, Beckmann, Valco VISF-2 and Altex valve injectors

Glass Barrel: Borosilicate 3.3  
Precision: <math>\lt; \pm 1\%</math> of the volume

Volume	Needle Tip Style Length O.D.	fixed b 51 mm	removable b 51 mm	TLL Luer Lock
<b>Flexible plunger</b>				
5 $\mu$ l	0.72 mm	2161302	2161306	-
10 $\mu$ l	0.72 mm	2161402	2161406	-
<b>Special stainless steel plunger</b>				
5 $\mu$ l	0.72 mm	2101302	2101306	-
10 $\mu$ l	0.72 mm	2101402	2101406	-
25 $\mu$ l	0.72 mm	2101502	2101506	-
50 $\mu$ l	0.72 mm	2101602	2101606	2101609
100 $\mu$ l	0.72 mm	2101702	2101706	2101709
250 $\mu$ l	0.72 mm	2101802	2101806	2101809
500 $\mu$ l	0.72 mm	2101902	2101906	2101909
<b>Special stainless steel plunger with PTFE-seal</b>				
5 $\mu$ l	0.72 mm	2601302	2601306	-
10 $\mu$ l	0.72 mm	2601402	2601406	-
25 $\mu$ l	0.72 mm	2601502	2601506	-
50 $\mu$ l	0.72 mm	2601602	2601606	2601609
100 $\mu$ l	0.72 mm	2601702	2601706	2601709
250 $\mu$ l	0.72 mm	2601802	2601806	2601809
500 $\mu$ l	0.72 mm	2601902	2601906	2601909

# HPLC Syringes

## 2. Waters Valves

Glass Barrel: Borosilicate 3.3  
 Precision: <math>< \pm 1\%</math> of the volume

Volume	Needle Tip Style Length O.D.	fixed b 50 mm	removable b 50 mm	TLL Luer Lock
<b>Flexible plunger</b>				
5 $\mu$ l	0.50 mm	2162302	2162306	-
10 $\mu$ l	0.50 mm	2162402	2162406	-
<b>Special stainless steel plunger</b>				
5 $\mu$ l	0.50 mm	2102302	2102306	-
10 $\mu$ l	0.50 mm	2102402	2102406	-
25 $\mu$ l	0.50 mm	2102502	2102506	-
50 $\mu$ l	0.50 mm	2102602	2102606	2102609
100 $\mu$ l	0.50 mm	2102702	2102706	2102709
250 $\mu$ l	0.50 mm	2102802	2102806	2102809
500 $\mu$ l	0.50 mm	2102902	2102906	2102909
<b>Special stainless steel plunger with PTFE-seal</b>				
10 $\mu$ l	0.50 mm	2602402	2602406	-
25 $\mu$ l	0.50 mm	2602502	2602506	-
50 $\mu$ l	0.50 mm	2602602	2602606	2602609
100 $\mu$ l	0.50 mm	2602702	2602706	2602709
250 $\mu$ l	0.50 mm	2602802	2602806	2602809
500 $\mu$ l	0.50 mm	2602902	2602906	2602909
1.0 ml	0.50 mm	2602006	2602007	2602003
2.5 ml	0.50 mm	2602026	-	-
<b>Special stainless steel plunger with extended handle</b>				
5 $\mu$ l	0.50 mm	-	2502304	-
10 $\mu$ l	0.50 mm	-	2502404	-
25 $\mu$ l	0.50 mm	-	2502504	-
50 $\mu$ l	0.50 mm	-	2502604	-
100 $\mu$ l	0.50 mm	-	2502704	-



# HPLC Syringes

## 3. Valco VISF-1 Valves

Glass Barrel: Borosilicate 3.3  
 Precision: <math>\pm 1\%</math> of the volume

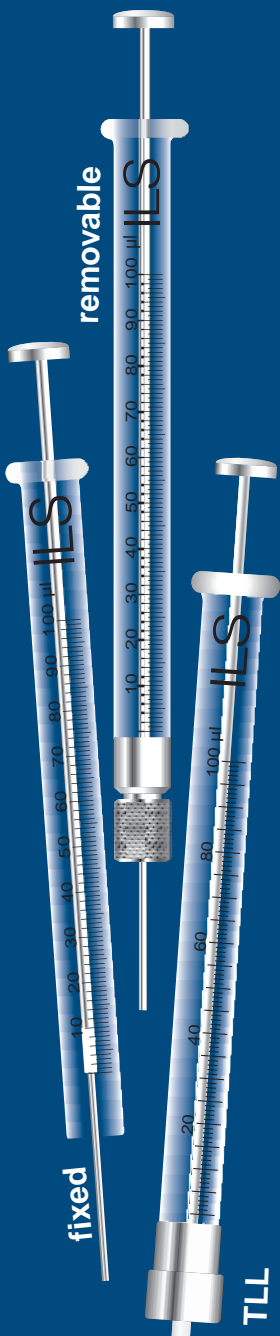

Volume	Needle Tip Style Length O.D.	fixed b 19 mm	removable b 19 mm	TLL Luer- Lock
<b>Flexible plunger</b>				
5 $\mu$ l	0.72 mm	2163303	2163307	-
10 $\mu$ l	0.72 mm	2163403	2163407	-
<b>Special stainless steel plunger</b>				
5 $\mu$ l	0.72 mm	2103303	2103307	-
10 $\mu$ l	0.72 mm	2103403	2103407	-
25 $\mu$ l	0.72 mm	2103503	2103507	-
50 $\mu$ l	0.72 mm	2103603	2103607	2103609
100 $\mu$ l	0.72 mm	2103703	2103707	2103709
250 $\mu$ l	0.72 mm	2103803	2103807	2103809
500 $\mu$ l	0.72 mm	2103903	2103907	2103909
<b>Special stainless steel plunger with PTFE-seal</b>				
10 $\mu$ l	0.72 mm	2603403	2603407	-
25 $\mu$ l	0.72 mm	2603503	2603507	-
50 $\mu$ l	0.72 mm	2603603	2603607	2603609
100 $\mu$ l	0.72 mm	2603703	2603707	2603709
250 $\mu$ l	0.72 mm	2603803	2603807	2603809
500 $\mu$ l	0.72 mm	2603903	2603907	2603909

# HPLC Syringes for Autosampler

## 1. Gynkotec Dionex Gina, Agilent (HP) 1090A, Hitachi, VWR

**Plunger:** Special stainless steel plunger with PTFE-seal

**Glass Barrel:** Borosilicate 3.3

**Precision:** < ±1% of the volume



### Gynkotec Dionex Gina

Volume	Needle Tip Style Length Series	removable a 51 mm O.D.	
25 µl	H	0.72 mm	2606505
250 µl	H	0.72 mm	2606805

### Hewlett Packard 1090A/Agilent

Volume	Series	Front Fitting	
25 µl	H	¼"-32UNEF	2606500
250 µl	H	¼"-32UNEF	2606800

### Hitachi L-7200/L-7250/L-2200/AS2000/AS42000

#### VWR LaChrom® Elite

Volume	Series	Front Fitting	
<b>PTFE-seal</b>			
100 µl	H	M10x1	2611712
500 µl	H	M10x1	2611912
1.0 ml	H	M10x1	2611012
2.5 ml	H	M10x1	2611032

#### PTFE-black-seal

100 µl	H	M10x1	2611715
500 µl	H	M10x1	2611915
1,0 ml	H	M10x1	2611015
2,5ml	H	M10x1	2611035

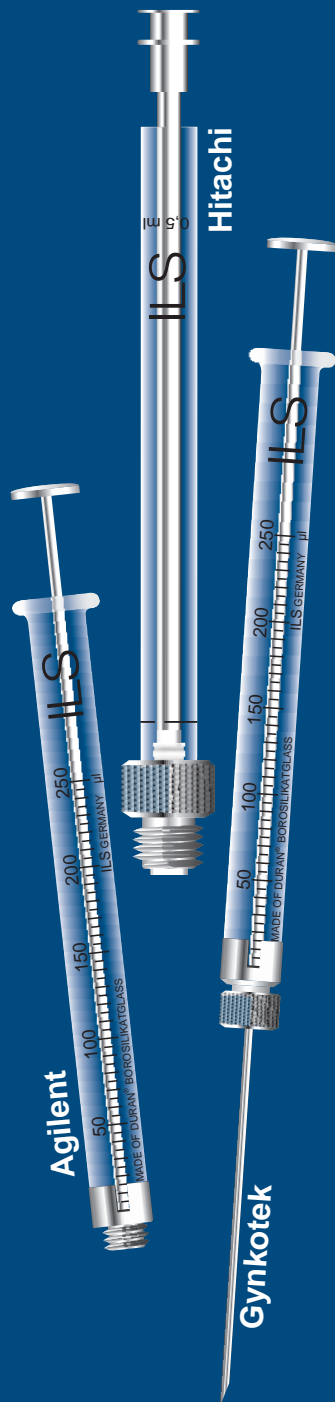

# HPLC Syringes for Autosampler

## 2. Waters, Spark, Kontron

**Plunger:** Stainless steel with PTFE-seal

**Glass Barrel:** Borosilicate 3.3

**Precision:** < ±1% of the volume

### Waters WISP®

plastic coated safety syringes

Volume	Series	Front Fitting / Plunger Top	
25 µl	H	¼"-28UNF / 4-40UNC	2663514
250 µl	H	¼"-28UNF / 4-40UNC	2663814

### Spark

Volume	Series	Front Fitting	
25 µl	H	¼"-28UNF	2608517
50 µl	H	¼"-28UNF	2608617
100 µl	H	¼"-28UNF	2608717
250 µl	H	¼"-28UNF	2608817
500 µl	H	¼"-28UNF	2608917
1.0 ml	H	¼"-28UNF	2608017

### Kontron

Volume	Series	Front Fitting	
250 µl	H	M8x0.75	2652816
500 µl	H	M8x0.75	2652916
1.0 ml	H	M8x0.75	2652016



Waters WISP®

WISP® is a registered trademark of Waters Corporation



# HPLC Syringes for Autosampler

## 3. LEAP Technologies, CTC,

LEAP, CTC -HTC PAL/ HTS PAL/ LC PAL

**Glass Barrel:** Borosilicate 3.3  
**Precision:** < ±1% of the volume  
**End piece:** golden colored indication for coated needle  
**Plunger:** guided for longer lifetime  
**Metal flange:** indication for needle inside diameter  
     red: G22s I.D. 0,20mm  
     blue: G22 I.D. 0,40mm  
**Plunger seal** PTFE-black-seal or PE-HD-seal  
**Needle with seal:** liquids have no contact with glue  
**Needle:** coated



Volume	Series	Glass barrel O.D. ø	Gauge	Needle Tip Style Length O.D.	fixed b 51 mm	seal
--------	--------	------------------------	-------	---------------------------------------	---------------------	------

### Stainless steel plunger with seal on the plunger top

10 µl	R	6.5 mm	22s coated	0.72 mm	<b>2620440</b>	PTFE-black
25 µl	R	6.5 mm	22s coated	0.72 mm	<b>2620540</b>	PTFE-black
25 µl	R	6.5 mm	22 coated	0.72 mm	<b>2620541</b>	PTFE-black
25 µl	R	6.5 mm	22s coated	0.72 mm	<b>2620542</b>	PE-HD
25 µl	R	6.5 mm	22 coated	0.72 mm	<b>2620543</b>	PE-HD
25 µl	R	7.8 mm	22s coated	0.72 mm	<b>2620544</b>	PTFE-black
25 µl	R	7.8 mm	22 coated	0.72 mm	<b>2620545</b>	PTFE-black
25 µl	R	7.8 mm	22s coated	0.72 mm	<b>2620546</b>	PE-HD
25 µl	R	7.8 mm	22 coated	0.72 mm	<b>2620547</b>	PE-HD
50 µl	R	6.5 mm	22s coated	0.72 mm	<b>2620640</b>	PTFE-black
50 µl	R	6.5 mm	22 coated	0.72 mm	<b>2620641</b>	PTFE-black
50 µl	R	6.5 mm	22 coated	0.72 mm	<b>2620643</b>	PE-HD
50 µl	R	6.5 mm	22s coated	0.72 mm	<b>2620642</b>	PE-HD
100 µl	R	6.5 mm	22s coated	0.72 mm	<b>2620740</b>	PTFE-black
100 µl	R	6.5 mm	22s coated	0.72 mm	<b>2620742</b>	PE-HD
100 µl	R	6.5 mm	22 coated	0.72 mm	<b>2620741</b>	PTFE-black
100 µl	R	6.5 mm	22 coated	0.72 mm	<b>2620743</b>	PE-HD
250 µl	R	6.5 mm	22s coated	0.72 mm	<b>2620840</b>	PTFE-black
250 µl	R	6.5 mm	22 coated	0.72 mm	<b>2620841</b>	PTFE-black

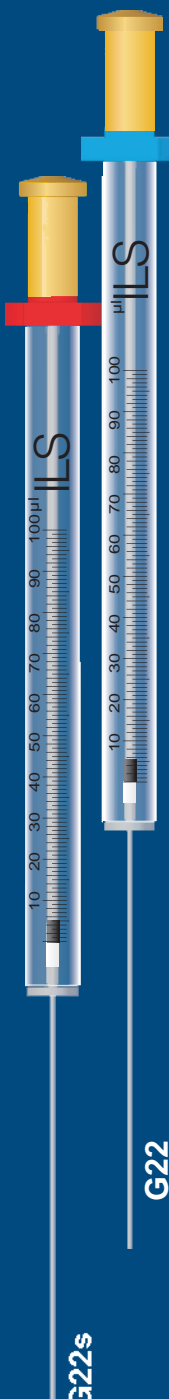



# HPLC Syringes for Autosampler

## LEAP Technologies, CTC

LEAP, CTC -HTC PAL/ HTS PAL/ LC PAL

Glass Barrel: Borosilicate 3.3  
Precision: < ±1% of the volume

A-Syringe™: Straight guided plunger  
Gastight  
longer lifetime

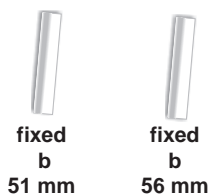

Volume	Series	glass barrel O.D.	Gauge	Needle Tip Style Length O.D.	fixed b 51 mm	fixed b 56 mm	seal
<b>Stainless steel plunger</b>							
10 µl	N	6.5 mm	22s	0.72 mm	2120402		-
10 µl	A	6.5 mm	22s	0.72 mm	2106447		-
<b>Stainless steel plunger with seal on the plunger top</b>							
10 µl	H	6.5 mm	22s	0.72 mm	2606416		PTFE
25 µl	H	7.8 mm	22s	0.72 mm	2620502		PTFE
25 µl	H	7.8 mm	22s	0.72 mm	2620520		PE-HD
25 µl	H	6.5 mm	22s	0.72 mm	2620517		PTFE
25 µl	H	6.5 mm	22s	0.72 mm	2620521		PE-HD
50 µl	H	6.5 mm	22s	0.72 mm	2620602		PTFE
50 µl	H	6.5 mm	22	0.72 mm	2620605		PTFE
50 µl	H	6.5 mm	22s	0.72 mm	2620609		PE-HD
50 µl	H	6.5 mm	22	0.72 mm	2620608		PE-HD
100 µl	H	6.5 mm	22s	0.72 mm	2620702		PTFE
100 µl	H	6.5 mm	22	0.72 mm	2620705		PTFE
100 µl	H	6.5 mm	22s	0.72 mm	2620709		PE-HD
100 µl	H	6.5 mm	22	0.72 mm	2620608		PE-HD
250 µl	H	7.8 mm	22	0.72 mm	2620805		PTFE
500 µl	H	7.8 mm	22	0.72 mm	2620908		PTFE
2.5 ml	H	9.8 mm	22	0.72 mm	2620041	2620030	PTFE
5.0 ml	H	13.5 mm	22	0.72 mm	2620058	2620056	PTFE

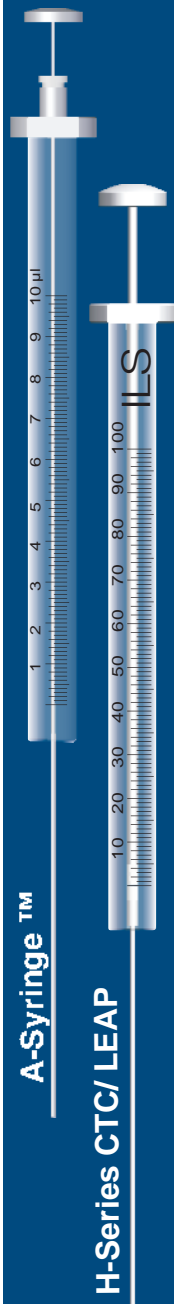

# HPLC Syringes for Autosampler

## 4. Thermo Finnigan, Thermo Separation, Varian

Plunger: Stainless steel with PTFE-seal

Glass Barrel: Borosilicate 3.3

Precision: < ±1% of the volume

Thermo Finnigan

Thermo Separation SP 8780/SP 8875/SP 8880

Thermo Separation AS 100/AS 300/AS 1000/AS 3000/AS 3500

Varian 9090

Volume	Front Fitting	H-C
100 µl	¼"-28UNF	2606714
250 µl	¼"-28UNF	2606814
500 µl	¼"-28UNF	2606914
1.0 ml	¼"-28UNF	2606015
2.5 ml	¼"-28UNF	2606035

## Perkin Elmer

Perkin Elmer Series 200 Autosampler

Volume	Front Fitting	H-CX	H-C
Special stainless steel plunger with PTFE-seal			
50 µl	¼"-28UNF	2606615	-
250 µl	¼"-28UNF	2606815	-
500 µl	¼"-28UNF	2606915	-
1.0 ml	¼"-28UNF		2606015
2.5 ml	¼"-28UNF		2606035

## Shimadzu SIL 6A

Volume	Series	Front Fitting	
Special stainless steel plunger with PTFE-seal			
100 µl	H	¼"-32UNEF	2606700

# Syringes for TLC

---

## CAMAG Linomat III and IV

**Glass Barrel:** Borosilicate 3.3  
**Precision:**  $< \pm 1\%$  of the volume  
**Needle:** especially developed for the needs of the Linomat III and IV  
**Main Use:** Thin Layer Chromatography (TLC)

Volume	Needle fixed
100 $\mu$ l	2606702

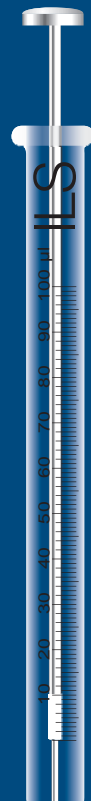

CAMAG

# Syringes for Automatic Liquid Handling

## 1. PTFE-Seals, Chemically Resistant Heavy Duty Syringes

**Plunger:** PTFE-seal  
**Glass Barrel:** Borosilicate 3.3  
**Precision:**  $< \pm 1\%$  of the volume  
**Stroke:** 60 mm

Volume	AD	DAD	DX	C	CX	RQ
10 $\mu$ l	-	-	-	2606414	2606415	-
25 $\mu$ l	-	-	2607516	2606514	2606515	2607512
50 $\mu$ l	2605613	2607618	2607616	2606614	2606615	2607612
100 $\mu$ l	2605713	2607718	2607716	2606714	2606715	2607712
250 $\mu$ l	2605813	2607818	2607816	2606814	2606815	2607812
500 $\mu$ l	2605913	2607918	2607916	2606914	2606915	2607912
1.0 ml	2605014	2607018	2607016	2606015	-	2607014
2.5 ml	2605034	2607038	-	2606035	-	2607034
5.0 ml	2605054	-	-	2606055	-	2607054
10.0 ml	2605074	-	-	2606075	-	2607074
25.0 ml	2605094	-	-	2606095	-	-

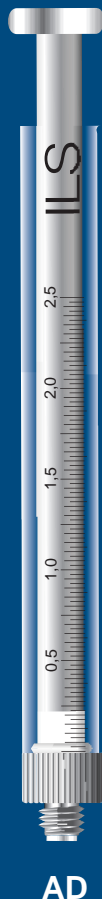

	AD	DAD	DX	C	CX	RQ
<b>Plunger Top</b>		With thread 6-32 UNC 	With thread 6-32 UNC 		With thread 6-32 UNC 	+Screw 
<b>Side Connection</b>		M6x1 	M6x1 			
<b>Front Fitting</b>	Screw M8x0.75 	Screw M8x0.75 	Luer 	Screw 1/4"x28 UNF 	Screw 1/4"x28 UNF 	Luer 

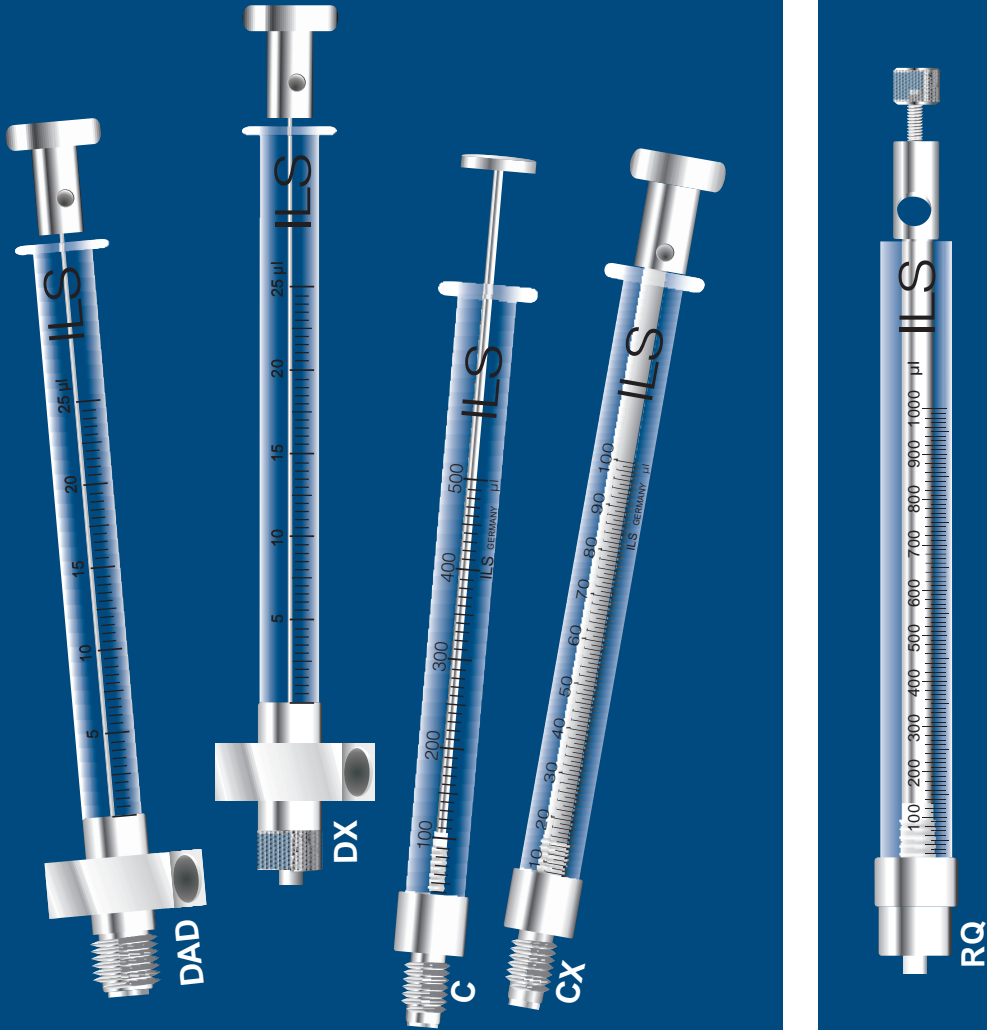

# Syringes for Automatic Liquid Handling

## 1. PTFE-Seals, Chemically Resistant Heavy Duty Syringes

Plunger: PTFE-seal  
 Glass Barrel: Borosilicate 3.3  
 Precision: <math>\pm 1\%</math> of the volume  
 Stroke: 60 mm

Volume	TLL	TLL-X	H-KP	XL	XLP	H-Gi 402	H-Gi 401
25 $\mu$ l	2607509	2607517	2608515	2607511	-	-	-
50 $\mu$ l	2607609	2607617	2608615	2607611	2679611	-	-
100 $\mu$ l	2607709	2607717	2608715	2607711	2679711	2629710	-
250 $\mu$ l	2607809	2607817	2608815	2607811	2679811	2629810	-
500 $\mu$ l	2607909	2607917	2608915	2607911	2679911	2629910	2629911
1.0 ml	2607011	2607017	2608015	2607013	2679011	2629015	2629013
2.5 ml	2607031	2607037	2608035	2607033	2679031	2629031	-
5.0 ml	2607051	2607057	2608055	2607053	2679051	2629051	2629053
10.0 ml	2607071	2607077	2608075	2607073	2679071	2629071	2629073
25.0 ml	2607091	-	2608091	2607096	2679091	-	-
50.0 ml	2607101	-	-	2607103	-	-	-
100.0 ml	2607121	-	-	-	-	-	-

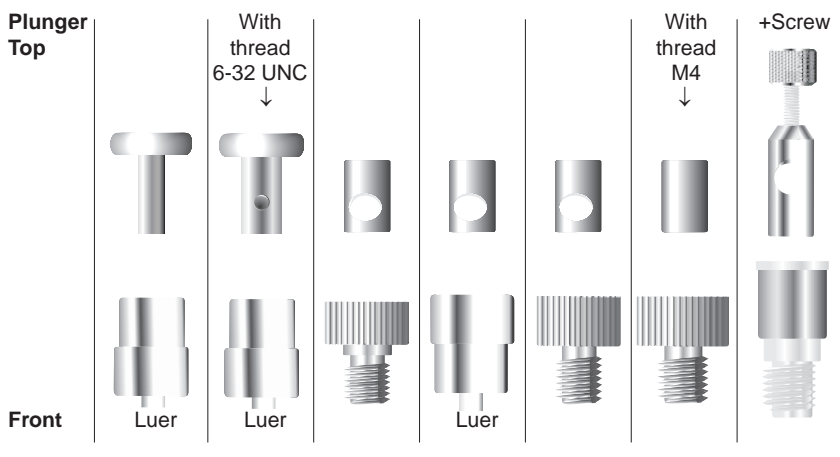
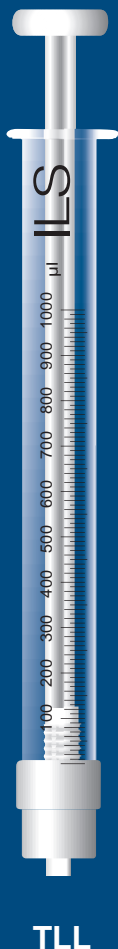

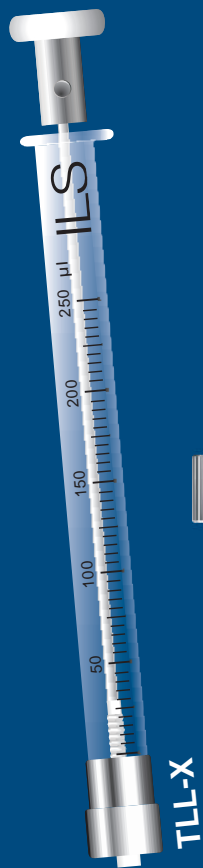

TLL-X

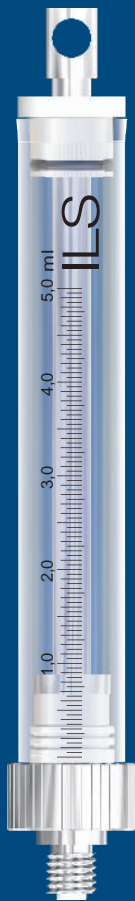

H-KP



XLP

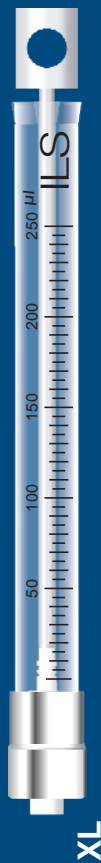

XL



H-Gi 402



H-Gi 401

# Syringes for Automatic Liquid Handling

## 1. PTFE-Seals, Chemically Resistant Heavy Duty Syringes

**Plunger:** PTFE-seal  
**Glass Barrel:** Borosilicate 3.3  
**Precision:** <  $\pm 1\%$  of the volume  
**Stroke:** 30 mm

Volume	XP-PD	H-PD	XP-XL	XE	XP-XL V3	XP
12.5 $\mu$ l	2676401	2658415	-	-	2685415	-
25 $\mu$ l	2676501	2658515	-	-	2685515	2607515
50 $\mu$ l	2676601	2658615	2676615	-	2685615	2607615
100 $\mu$ l	2676701	2658715	2676715	-	2685715	2607715
125 $\mu$ l	2676702	2658714	-	-	-	-
250 $\mu$ l	2676801	2658815	2676815	-	2685815	2607815
500 $\mu$ l	2676901	2658915	2676915	2607921	2685915	2607915
1.0 ml	2676011	2658014	2676015	2607021	2685015	2607015
1.25 ml	2676012	2658015	-	-	-	-
2.5 ml	2676031	2658035	2676035	2607041	2685035	2607035
5.0 ml	2676051	2658055	2676055	2607061	2685055	2607075



H-PD

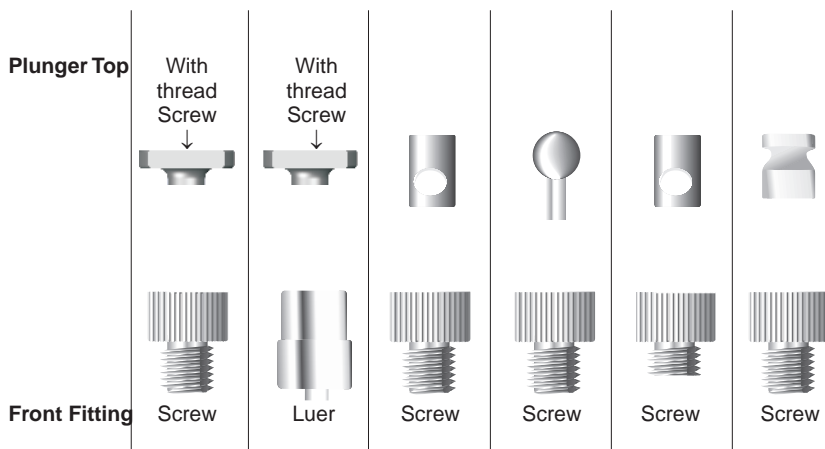





XP-XL



H-PD



XE



XP-XL V3

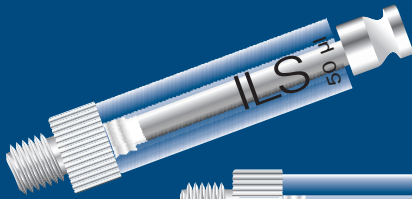

XP



XP

# Syringes for Automatic Liquid Handling

## 2. Modified PTFE-Seals for Buffers

Specially designed for handling of strong buffers and other aqueous solutions. The modified PTFE-seals guarantee extended lifetime under heavy duty conditions.

**Plunger:** PTFE-seal  
**Glass Barrel:** Borosilicate 3.3  
**Precision:**  $< \pm 1\%$  of the volume  
**Stroke:** 60 mm

Volume	AD	DAD	DX	C	CX
25 $\mu$ l	-	-	2627517	2606517	2606527
50 $\mu$ l	2605617	2626617	2627617	2606617	2606627
100 $\mu$ l	2605717	2626717	2627717	2606717	2606727
250 $\mu$ l	2605817	2626817	2627817	2606817	2606827
500 $\mu$ l	2605917	2626917	2627917	2606917	2606927
1.0 ml	2605017	2626017	2627017	2606017	-
2.5 ml	2605037	2626037	-	2606037	-
5.0 ml	2605057	-	-	2606057	-

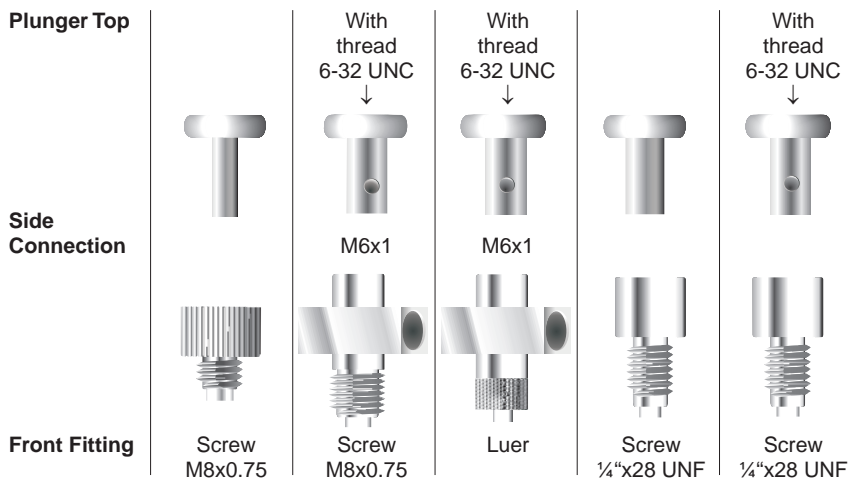
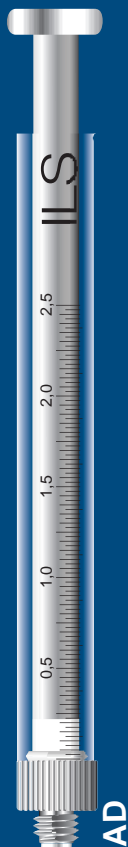

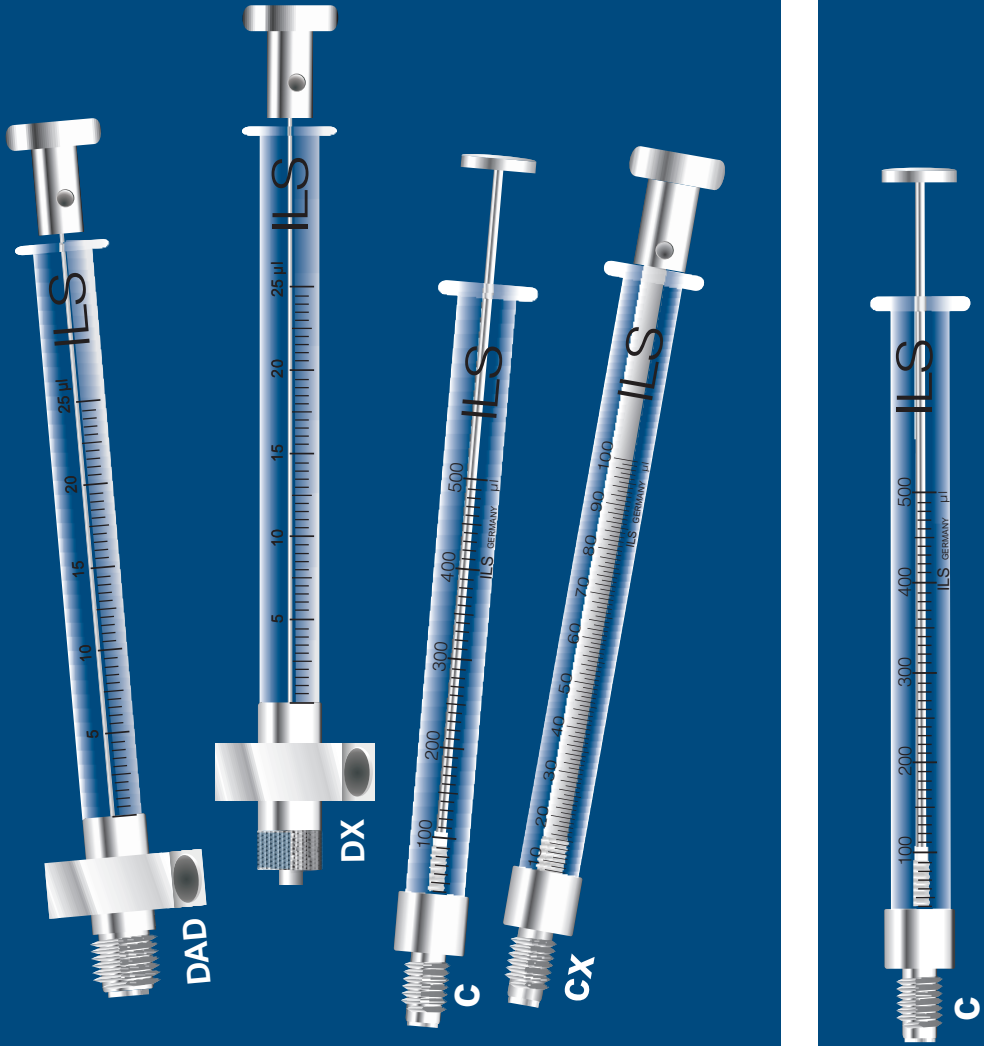

# Syringes for Automatic Liquid Handling

## 2. Modified PTFE-Seals for Buffers

Specially designed for handling of strong buffers and other aqueous solutions. The modified PTFE-seals guarantee extended lifetime under heavy duty conditions.

**Plunger:** PTFE-seal  
**Glass Barrel:** Borosilicate 3.3  
**Precision:** <  $\pm 1\%$  of the volume  
**Stroke:** 60 mm

Volume	TLL	TLL-X	RQ	XL
25 $\mu$ l	2641517	2643517	2644517	2645517
50 $\mu$ l	2641617	2643617	2644617	2645617
100 $\mu$ l	2641717	2643717	2644717	2645717
250 $\mu$ l	2641817	2643817	2644817	2645817
500 $\mu$ l	2641917	2643917	2644917	2645917
1.0 ml	2641017	2643017	2644017	2645017
2.5 ml	2641037	2643037	2644037	2645037
5.0 ml	2641057	2643057	2644057	2645057
10.0 ml	2641077	2643077	2644077	2645077

Plunger Top

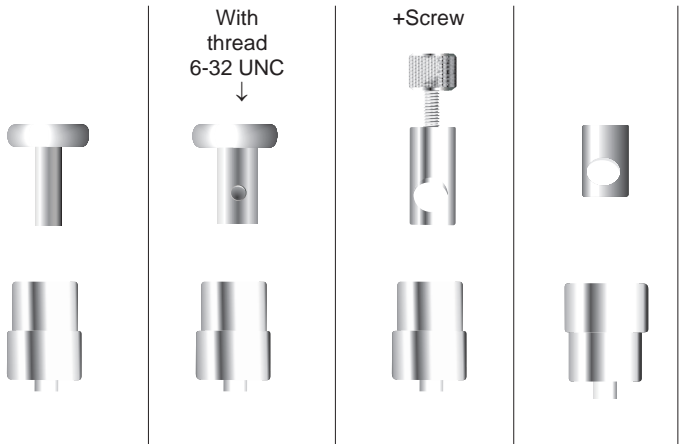



TLL-X

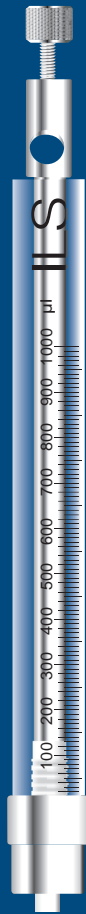

RQ

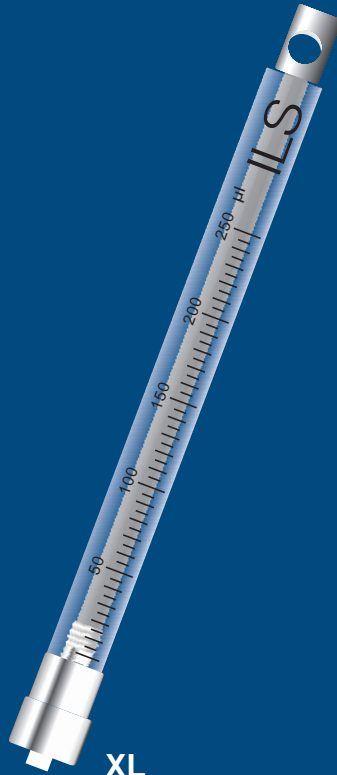

XL

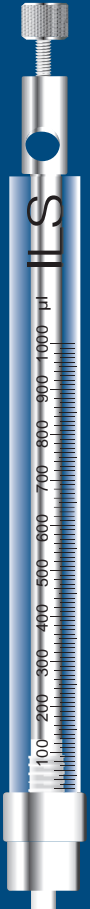

RQ

# Syringes for Automatic Liquid Handling

## 2. Modified PTFE-Seals for Buffers

Specially designed for handling of strong buffers and other aqueous solutions. The modified PTFE-seals guarantee extended lifetime under heavy duty conditions.

**Plunger:** PTFE-seal  
**Glass Barrel:** Borosilicate 3.3  
**Precision:** < ±1% of the volume  
**Stroke:** 30 mm

Volume	H-PD	XE	XP
12.5 µl	2666415	-	-
25 µl	2666515	-	2647517
50 µl	2666615	-	2647617
100 µl	2666715	-	2647717
125 µl	2666714	-	-
250 µl	2666815	-	2647817
500 µl	2666915	2646927	2647917
1.0 ml	2666014	2646027	2647017
1.25 ml	2666015	-	-
2.5 ml	2666035	2646047	2647037
5.0 ml	2666055	2646067	2647077
12.5 ml	2666074	-	-



H-PD

Plunger Top

With  
thread  
6-32 UNC  
↓



Front Fitting

Luer

Screw

Screw



H-PD

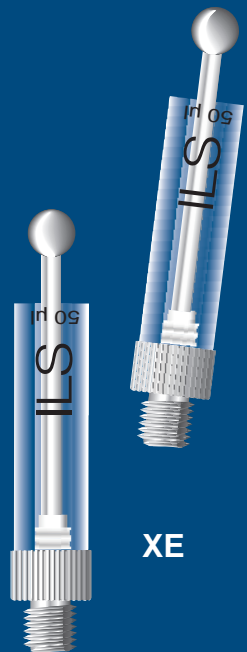

XE



XP

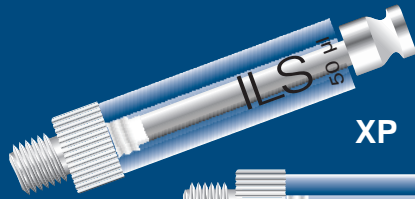

XP



# Syringes for Automatic Liquid Handling

## 3. Special PE-Seals for Smoother Operation

Specially designed for handling of strong buffers and other aqueous solutions. The special PE-seals run smoother than conventional seals. Good resistance to buffers and aqueous solutions, long lifetime.

**Plunger:** PE-seal (Polyethylene)  
**Glass Barrel:** Borosilicate 3.3  
**Precision:** < ±1% of the volume  
**Stroke:** 60 mm

Volume	AD	DAD	DX	C	CX
50 µl	2605618	2626618	2627618	2606618	2606628
100 µl	2605718	2626718	2627718	2606718	2606728
250 µl	2605818	2626818	2627818	2606818	2606828
500 µl	2605918	2626918	2627918	2606918	2606928
1.0 ml	2605018	2626018	2627018	2606018	-
2.5 ml	2605038	2626038	-	2606038	-
5.0 ml	2605058	-	-	2606058	-

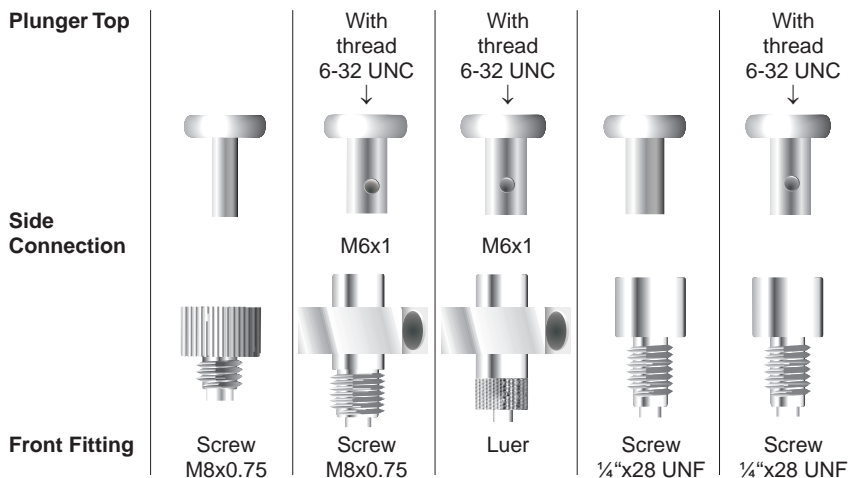
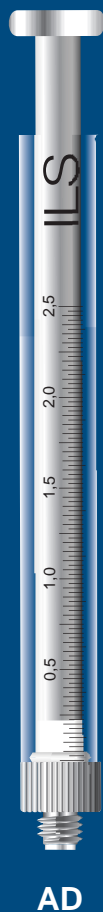



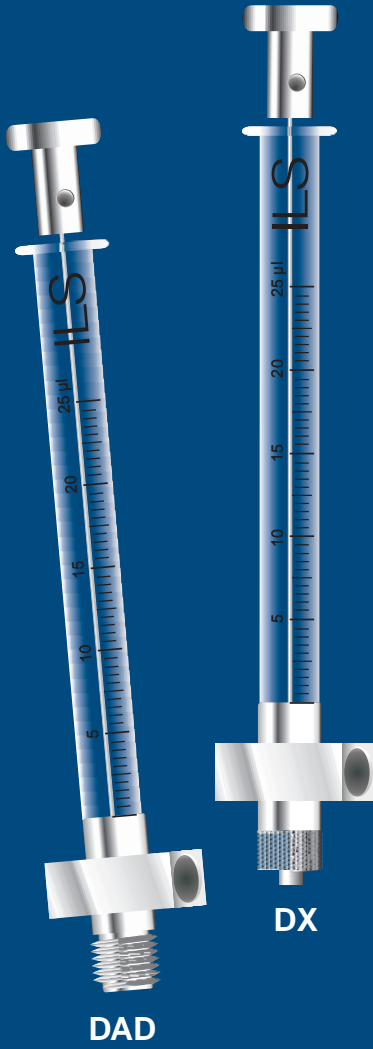

DAD

DX

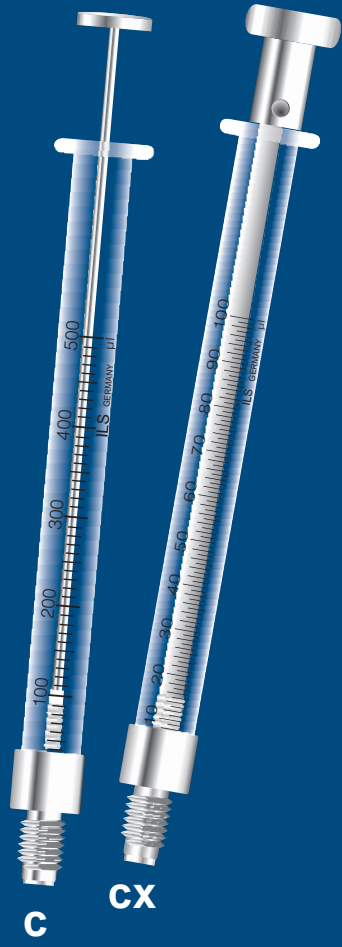

C

CX

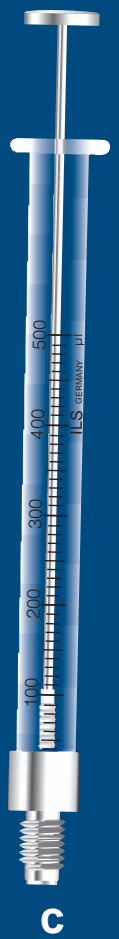

C

# Syringes for Automatic Liquid Handling

## 3. Special PE-Seals for Smoother Operation

Specially designed for handling of strong buffers and other aqueous solutions. The special PE-seals run smoother than conventional seals. Good resistance to buffers and aqueous solutions, long lifetime.

**Plunger:** PE-seal (Polyethylene)

**Glass Barrel:** Borosilicate 3.3

**Precision:** <  $\pm 1\%$  of the volume

**Stroke:** 60mm

Volume	TLL	TLL-X	H-KP	RQ	XL	XLP
50 $\mu$ l	2641618	2643618	2608616	2644618	2645618	2679613
100 $\mu$ l	2641718	2643718	2608716	2644718	2645718	2679713
250 $\mu$ l	2641818	2643818	2608816	2644818	2645818	2679813
500 $\mu$ l	2641918	2643918	2608916	2644918	2645918	2679913
1.0 ml	2641018	2643018	2608016	2644018	2645018	2679015
2.5 ml	2641038	2643038	2608036	2644038	2645038	2679035
5.0 ml	2641058	2643058	2608056	2644058	2645058	2679055

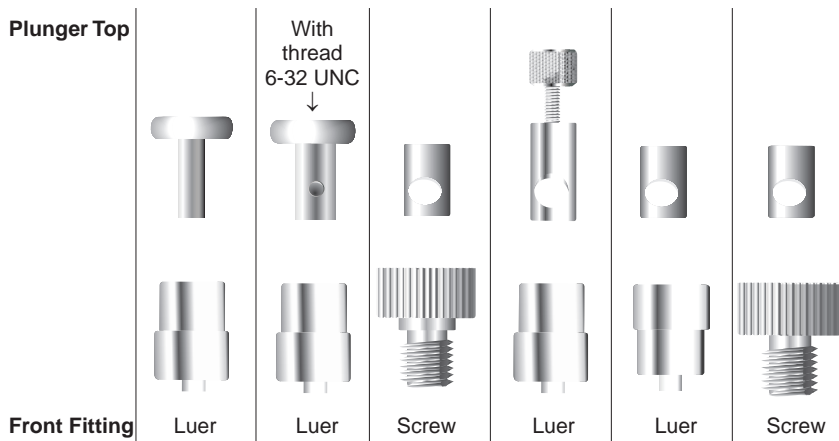
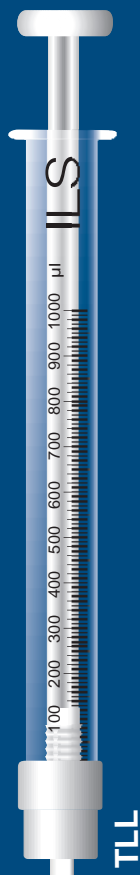

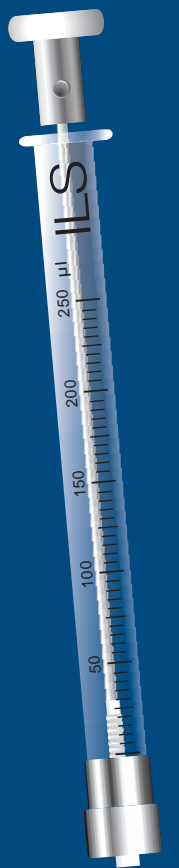

**TLL-X**

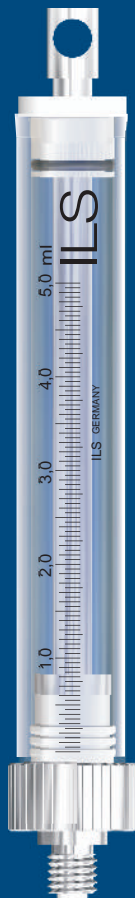

**H-KP**

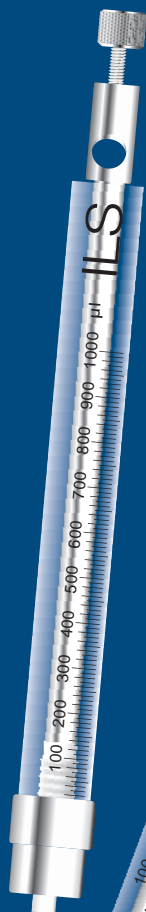

**RQ**



**XL**



**XLP**

# Syringes for Automatic Liquid Handling

## 3. Special PE-Seals for Smoother Operation

Specially designed for handling of strong buffers and other aqueous solutions. The special PE-seals run smoother than conventional seals. Good resistance to buffers and aqueous solutions, long lifetime.

**Plunger:** PE-seal (Polyethylene)  
**Glass Barrel:** Borosilicate 3.3  
**Precision:** < ±1% of the volume  
**Stroke:** 30 mm

Volume	H-PD	XE	XP
25 µl	2665515	-	-
50 µl	2665615	-	2647618
100 µl	2665715	-	2647718
125 µl	2665714	-	-
250 µl	2665815	-	2647818
500 µl	2665915	2646928	2647918
1.0 ml	2665014	2646028	2647018
1.25 ml	2665015	-	-
2.5 ml	2665035	2646048	2647038



H-PD

Plunger Top

With  
thread  
6-32 UNC  
↓



Front Fitting



Luer



Screw



Screw

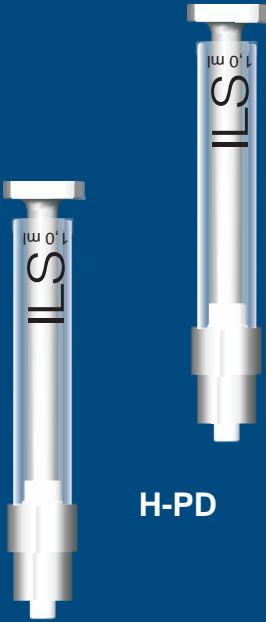

H-PD

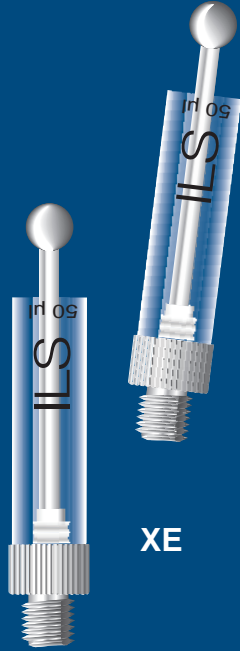

XE

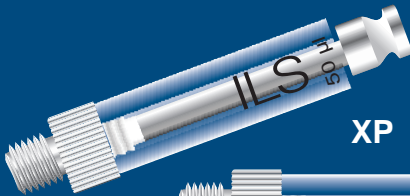

XP



XP

# Syringes for Automatic Liquid Handling

## 4. ABI, Abbott, Selectra, H-I, Varian

**Plunger:** Stainless steel with PTFE-seal  
**Glass Barrel:** Borosilicate 3.3  
**Precision:** <  $\pm 1\%$  of the volume  
**Stroke:** 60 mm

### ABI PRISM® for Genetic Analyser

Volume	Series	Front Fitting	
1 ml	H	¼"-32 UNEF	2618011

### Syringe for Abbott CELL-DYN®

Volume	Series	Front Fitting	
10 ml	H	TLL	2607081

### Syringe for Selectra

Volume	Series	Front Fitting	
100 µl	H	M8x0.75	2605714
500 µl	H	M8x0.75	2605914
1.0 ml	H	M8x0.75	2605013

### H-I

Volume	Series	Front Fitting	
250 µl	HI	¼"-28 UNEF	2623815
500 µl	HI	¼"-28 UNEF	2623915
1.0 ml	HI	¼"-28 UNEF	2623015

### Varian

Volume	Series	Front Fitting	
100 µl	H	M8x1	2607706

ABI PRISM® is a registered trademark of Perkin Elmer, USA  
CELL-DYN® is a registered trademark of Abbott Laboratories, USA

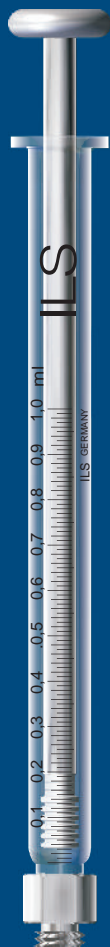



Abbott



Selectra



H-I



Varian

# Valves

## Valve RQ for Rosys/ Qiagen/ Zinsser Analytic

	Fitting	Ports	Flow Path	Syringe Connection	Fluid Contact Material
2700040	M6	4-Port-90°		Luer	PTFE/PCTFE
2700045	1/4"-28UNF	4-Port-90°		Luer	PTFE/ PCTFE

## Valve for VP 9101 ILS/ Stratec

	Fitting	Ports	Flow Path	Syringe Connection	Fluid Contact Material
2709102	1/4"-28UNF	3-Port-120°		1/4"-28UNF	PTFE/PCTFE

## Valve for VP 9100 ILS/ Stratec

	Fitting	Ports	Flow Path	Syringe Connection	Fluid Contact Material
2700091	1/4"-28UNF	3-Port-120°		1/4"-28UNF	PTFE/PCTFE

## Valve XE for Tecan/ Cavo

	Fitting	Ports	Flow Path	Syringe Connection	Fluid Contact Material
2700080	M6	3-Port-120°		1/4"-28UNF	PTFE/PCTFE
2700081	1/4"-28UNF	3-Port-120°		1/4"-28UNF	PTFE/PCTFE







## Valve for Cybertron

	Fitting	Ports	Flow Path	Syringe Connection	Fluid Contact Material
2700064	1/4"-28UNF	3-Port-120°		1/4"-28UNF	PTFE/PCTFE





# Valves

## Valve XP for Tecan/Cavro

	Fitting	Ports	Flow Path	Fluid Contact Material
2700060	1/4"-28UNF	3-Port-120°		PTFE/ PCTFE
2700065	1/4"-28UNF	4-Port-90°		PTFE/ PCTFE
2700066	1/4"-28UNF	3-Port-T-90°		PTFE/ PCTFE
2700067	1/4"-28UNF	4-Port-90°		PTFE/ PCTFE
2700068	1/4"-28UNF	3-Port-120° Distribution		- PCTFE
2700069	M6	3-Port-120°		PTFE/ PCTFE



## Valve for Manual Sampling

	Fitting	Ports	Flow Path	Fluid Contact Material
2700009*	Luer	3-Port-T	 	PTFE/PCTFE



\* For transporting and storing samples in gastight TLL-syringes.

# Syringes with PEEK-Tubing Connectors

**Plunger:** PTFE-seal  
**Glass Barrel:** Borosilicate 3.3  
**Precision:** < ±1% of the volume  
 - direct connection  
 - reduced dead volume  
 - totally inert, no metal contact  
 - fits any tube from 0.8 to 3.2 mm Ø  
 - highly resistant  
**Stroke:** 60 mm

Volume	Series	Connector		
10 µl	H	M6	tubing connector	2624414
25 µl	H	M6	tubing connector	2624514
50 µl	H	M6	tubing connector	2624614
100 µl	H	M6	tubing connector	2624714
250 µl	H	M6	tubing connector	2624814
500 µl	H	M6	tubing connector	2624914
1.0 ml	H	M6	tubing connector	2624015
2.5 ml	H	M6	tubing connector	2624035
5.0 ml	H	M6	tubing connector	2624055
10.0 ml	H	M6	tubing connector	2624075
25.0 ml	H	M6	tubing connector	2624096
50.0 ml	H	M6	tubing connector	2624107
100.0 ml	H	M6	tubing connector	2624118

Volume	Series	Connector		
10 µl	H	1/4 x 28"	tubing connector	2624415
25 µl	H	1/4 x 28"	tubing connector	2624515
50 µl	H	1/4 x 28"	tubing connector	2624615
100 µl	H	1/4 x 28"	tubing connector	2624715
250 µl	H	1/4 x 28"	tubing connector	2624815
500 µl	H	1/4 x 28"	tubing connector	2624915
1.0 ml	H	1/4 x 28"	tubing connector	2624016
2.5 ml	H	1/4 x 28"	tubing connector	2624036
5.0 ml	H	1/4 x 28"	tubing connector	2624056
10.0 ml	H	1/4 x 28"	tubing connector	2624076
25.0 ml	H	1/4 x 28"	tubing connector	2624097
50.0 ml	H	1/4 x 28"	tubing connector	2624108
100.0 ml	H	1/4 x 28"	tubing connector	2624119

Tubing Connector

# Accessories for Connectors

## Male Fittings, 10 per Pack

Thread	for Tubing with O.D.	
M 6	3.2 mm (1/18")	4130005
1/4x28"	3.2 mm (1/18")	4130020
M 6	1.6 mm (1/16")	4130016
1/4x28"	1.6 mm (1/16")	4130019

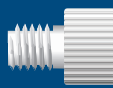
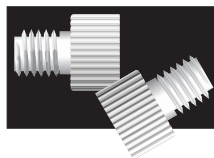

Fitting Plug

## Washers, 10 per Pack

for Tubing with O.D.	
3.2 mm	4132032
1.6 mm	4132016



Washer

## Complete sets

Set size	Description	
Set 3.2 x 1.6	tubing 3.2 x 1.6 + fitting M 6 + washer	4133032
Set 3.2 x 1.6	tubing 3.2 x 1.6 + fitting 1/4 x 28" + washer	4133033
Set 1.6 x 0.8	tubing 1.6 x 0.8 + fitting M 6 + washer	4133168
Set 1.6 x 0.8	tubing 1.6 x 0.8 + fitting 1/4 x 28" + washer	4133169
Set 1.6 x 0.5	tubing 1.6 x 0.5 + fitting M 6 + washer	4133165
Set 1.6 x 0.5	tubing 1.6 x 0.5 + fitting 1/4 x 28" + washer	4133166

## Flange Tool for Tubings

You can shape a few simple steps stable, conical flanges to medium-polymer (PTFE, Teflon, Tefzel, PE, PP, etc.) of 1.6 to 3.2 mm diameter quickly and easily. The tools are in a stable box.

### Description

Flange tool 2700181

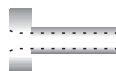

# Syringes with Adjustable Internal Stopper

**Plunger:** Stainless steel with PTFE-seal  
**Glass Barrel:** Borosilicate 3.3  
**Precision:** <math>\lt; \pm 1\%</math> of the volume  
 - excellent for routine dosages  
 - internal index stop is adjustable to any volume  
 - for faster work and better reproducibility

**Stroke:** 60 mm

## TLL PTFE-Luer-Lock



Volume	Series	Description	
2.5 ml	H-TLL	with stopper	2614031
5.0 ml	H-TLL	with stopper	2614051
10.0 ml	H-TLL	with stopper	2614071

## TLT PTFE-Luer-Tip



Volume	Series	Description	
2.5 ml	H-TLT	with stopper	2614034
5.0 ml	H-TLT	with stopper	2614054

H-TLL with Stopper

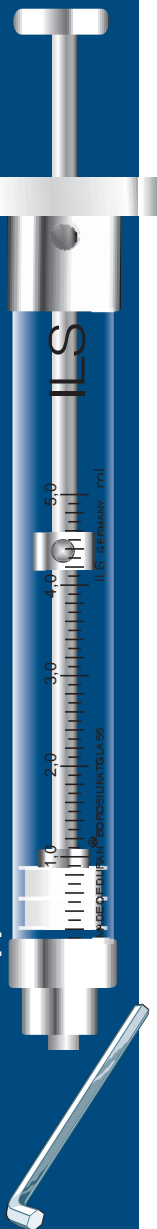

# Syringes with Push Button Valve

---

<b>Plunger:</b>	Stainless steel with PTFE-seal
<b>Glass Barrel:</b>	Borosilicate 3.3
<b>Precision:</b>	< $\pm 1\%$ of the volume
	- excellent for routine dosages
	- internal index stop is adjustable to any volume
	- for faster work and better reproducibility
<b>Stroke:</b>	60 mm

## Syringe with Push Button Valve and Luer Tip

Volume	Series	Description	
25 $\mu$ l	HVPB	Luer Male Push Button Valve	2680521
50 $\mu$ l	HVPB	Luer Male Push Button Valve	2680621
100 $\mu$ l	HVPB	Luer Male Push Button Valve	2680721
250 $\mu$ l	HVPB	Luer Male Push Button Valve	2680821
500 $\mu$ l	HVPB	Luer Male Push Button Valve	2680921
1.0 ml	HVPB	Luer Male Push Button Valve	2680011
2.5 ml	HVPB	Luer Male Push Button Valve	2680031
5.0 ml	HVPB	Luer Male Push Button Valve	2680051
10.0 ml	HVPB	Luer Male Push Button Valve	2680071
25.0 ml	HVPB	Luer Male Push Button Valve	2680091
50.0 ml	HVPB	Luer Male Push Button Valve	2680101

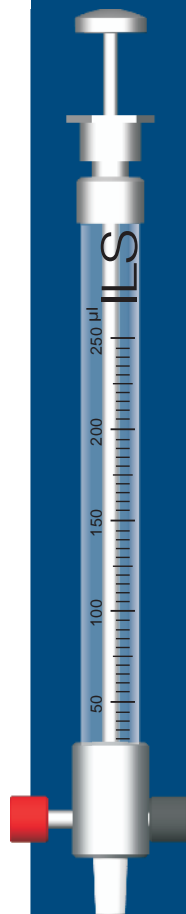

**HVPB**

# Accessories

## Fittings, 10 per Pack

Thread	for Tubing with O.D.	
M 6	3.2 mm (1/18")	4130005
1/4 x 28"	3.2 mm (1/18")	4130020
M 6	1.6 mm (1/16")	4130016
1/4 x 28"	1.6 mm (1/16")	4130019
M 6	2.7 mm	4130004
1/4 x 28"	2.7 mm	4130025

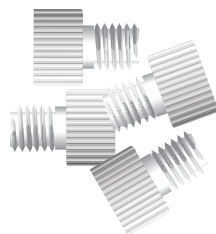

## Washers, 10 per Pack

for Tubing with O.D.		
3.2 mm		4132032
1.6 mm		4132016
2.7 mm		4132031



## Plugs for Valves, 10 per Pack

Thread	
M 6	4130021
1/4 x 28"	4130022

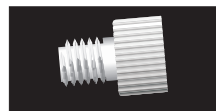

## Female Luer Caps, 10 per Pack 2702206

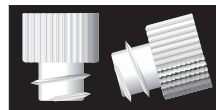

## Flange Tool for Tubings

You can shape a few simple steps stable, conical flanges to medium-polymer (PTFE, Teflon, Tefzel, PE, PP, etc.) of 1.6 to 3.2 mm diameter quickly and easily. The tools are in a stable box.

### Description

Flange tool	2700181
-------------	---------

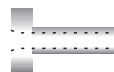
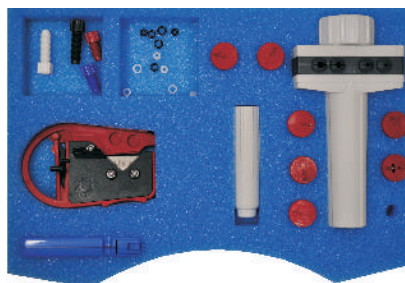

# Syringe Guide, Cleaning Wires, Rack

## Syringe Guide

made of stainless steel and anodized aluminum

2700001

## Cleaning Wires, 12 per Pack

### Gauge

### O.D.

26s, 31, 33	0.09 mm	21018300
22s, 25s, 28, 30	0.13 mm	21018301
27	0.16 mm	21018302
24, 26	0.20 mm	21018303

## Syringe Rack

for 3 syringes

2700002

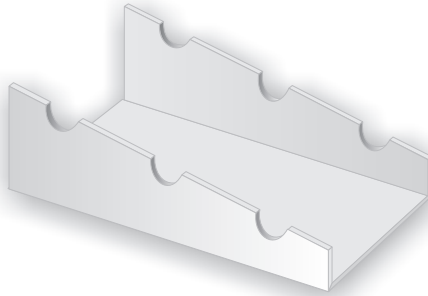

## Syringe Rack

for 8 syringes  
(without syringes)

2700201



## Guide

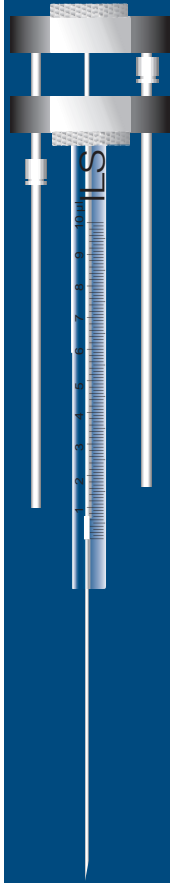

# Custom Made Products

---

## **You name it - we make it!**

Contact us for special developments.  
We are allways ready to break new



# Repair & Maintenance Service

---

We offer an extensive maintenance and repair service for microsyringes of all brands. To ensure a safe and quick repair, the syringes should be cleaned and decontaminated carefully before sending back to us.

**Please ship, freight and duty prepaid, to:**

**ILS Innovative Labor Systeme GmbH  
Repair Service  
Mittelstrasse 37  
98714 Stützerbach  
Germany**